

VISION TOUCH WELLNESS



User and maintenance manual

ENGLISH

READ AND KEEP

Rel. Software: VT_WEL_5_0_0_2

Thank you for choosing PEGO'S VISION TOUCH WEL controller.

Reading this manual thoroughly will guide you through proper installation and better use of the various features. We therefore recommend keeping this manual near the controller to make use of it during the device installation, configuration and use.

Waste disposal guidelines:

The Vision Touch controller consists of glass parts, plastic parts and metal parts. With reference to the Directive 2012/19/EC of the European Parliament and of the Council of 4 July 2012 and related national legislation, please note that:

- A. There is the obligation not to dispose of WEEE as urban waste and to perform separate collection of this waste.
- B. Public or private waste collection facilities foreseen by local laws must be used to dispose of the materials. It is also possible to give the device back to the distributor at the end of its life when purchasing a new one.
- C. This equipment can contain dangerous substances: improper use or incorrect waste disposal could have negative effects on human health and on the environment.



- D. The symbol  (crossed-out waste bin on wheels) applied to the pack, product and instructions indicates that the appliance was placed on the market after August 13, 2005, and must be disposed of separately.
- E. In case of abusive disposal of electrical and electronic waste, there are sanctions established by local standards in force concerning waste disposal.

CONTENTS

INTRODUCTION

Page 5	1.1	General information
Page 6	1.2	Product identification codes
Page 7	1.3	Overall dimensions
Page 7	1.4	Identification data
Page 8	1.5	Technical features

CHAPTER 1

INSTALLATION

Page 9	2.1	General rules for the installer
Page 9	2.2	Standard equipment for assembly and use
Page 10	2.3	Installation and assembly

CHAPTER 2

ELECTRICAL CONNECTIONS

Page 12	3.1	Console / 100N MASTER3 power supply and connection
Page 14	3.2	Connection of digital outputs on 100N MASTER3
Page 15	3.3	Connection of digital inputs on 100N MASTER3
Page 16	3.4	Connection of analogue inputs on 100N MASTER3
Page 17	3.5	Connection of analogue outputs on 100N MASTER3
Page 18	3.6	Connection to RS-485 for TeleNET or Modbus- RTU

CHAPTER 3

SWITCHING ON

Page 19	4.1	Commissioning
Page 20	4.2	Switch-on controller

CHAPTER 4

USER INTERFACE

Page 21	5.1	Console functional zones
Page 22	5.2	Main display
Page 22	5.3	Status bar
Page 23	5.4	Button bar
Page 25	5.5	Gesture

CHAPTER 5

HOME PAGES

Page 29	6.1	HOME 1 – Temperature / Humidity, I/O status management
Page 32	6.2	HOME 1 – Temperature / Humidity Set point Modification
Page 33	6.3	CHROMOTHERAPY
Page 34	6.4	HOME 2
Page 34	6.5	HOME 2 – Scheduled switch-on
Page 35	6.6	HOME 2 – Scheduled switch-off
Page 36	6.7	HOME 2 – Weekly programmable thermostat

CHAPTER 6

ACCESS LEVELS

Page 38	7.1	Access levels to parameters (User / installer)
Page 38	7.2	Lock screen and User / installer login

CHAPTER 7

PARAMETERS

CHAPTER 8

Page 39	8.1	Access to the "Parameters" menu
Page 40	8.2	Description of parameters setting page
Page 41	8.3	Parameters menu items list
Page 43	- 8.3.1	Process adjustment
Page 44	- 8.3.2	Air change
Page 44	- 8.3.3	Configure WELLNESS
Page 45	- 8.3.4	Machine protection
Page 45	- 8.3.5	Probes calibration
Page 46	- 8.3.6	Configuration RS485
Pag. 47	- 8.3.7	Web server
Pag. 51	- 8.3.8	Mail
Page 52	- 8.3.9	Humidifier PEGO
Page 53	- 8.3.10	RGB
Page 53	- 8.3.11	Language
Page 54	- 8.3.12	Date and time
Page 55	- 8.3.13	General settings
Page 56	- 8.3.14	Software
Page 57	- 8.3.15	Info
Page 58	- 8.3.16	Password
Page 60	- 8.3.17	Test center
Page 65	- 8.3.18	Configure I/O
Page 70	- 8.3.19	I/O status

DIAGNOSTICS

CHAPTER 9

Page 71	9.1	Diagnostics
Page 73	9.2	PEGO humidifier's diagnostics
Page 75	9.3	Alarms management
Page 76	9.4	Pop-up management

WEB SERVER

CHAPTER 10

Pag. 77	10.1	Installation
Pag. 79	10.2	Interfaccia web: accesso utente
Pag. 80	10.3	Interfaccia web: pagine

OPERATION

CHAPTER 11

Page 88	11.1	WELLNESS configuration: Sauna
Page 88	11.2	WELLNESS configuration: Wet sauna
Page 89	11.3	WELLNESS configuration: Turkish bath
Page 90	11.4	New software features

ACCESSORIES

CHAPTER 12

Page 91	12.1	400SAUNASENS
---------	------	--------------

APPENDICES

Page 92	A.1	EU Declaration of Conformity
Page 93	A.2	Warranty terms

CHAPTER 1: INTRODUCTION

1.1

GENERAL INFORMATION

DESCRIPTION:

The **VISION TOUCH WELLNESS** allows for advanced management of saunas, steam rooms and Turkish baths.

The system consists of the 100N MASTER3 unit, on which all the electrical connections are made, and the VISION TOUCH WEL control console, equipped with 7" TFT display with capacitive touch screen combined with a highly advanced software and a highly user friendly interface that allows easy use.

APPLICATIONS:

- Saunas.
- Wet saunas.
- Turkish bath (only with combined Easysteam humidifier).

TECHNICAL SPECIFICATIONS FOR WELLNESS:

- Manual or automatic switch-on (by setting a single time or with weekly programmable thermostat)
- Drying cycle configurable at the end of the operating period (only ventilation or ventilation and heating).
- Maximum settable time of operation up to 12 hours.
- Temperature regulation range: 0°C/+99°C.
- Humidity regulation range: 0-100 R.H.%, with a maximum programmable value in accordance with standard EN60335-2-53:2012.
- Internal light control.
- RGB light control (Chromotherapy, requires external controller).

For appliances for use in blocks of flats, hotels and similar locations, the operating period of the sauna heater shall be limited to 12 h with a minimum rest period of 6 h before any automatic restarting. For other appliances, the operating period of the timer shall be limited to 6 h, automatic restarting not being allowed (reference to standard EN60335-2-53:2012, section 22.103).

GENERAL CHARACTERISTICS OF THE CONTROLLER:

- 7" TFT display with high resolution (800x480 WVGA), LED backlighting and capacitive touch screen.
- Front with 1,1mm chemically treated glass.
- Ability to reverse the viewing angle of the display to ensure the possibility of mounting at any height.
- Devices: USB 2.0, microSD, RS485.
- Acoustic signals.
- IP65 frontal protection.
- High quality design and icons.
- Touch screen interface with gestures, for an even more intuitive control.
- Clock and calendar (RTC).
- Password function.
- Multilingual.
- Customizable user parameter menu (unused features can be hidden, simplifying the menu).
- Contextual help in the parameter configuration menu.
- Software updating from microSD or USB.
- Ability to export and import parameters on USB or microSD media.
- Alarm history combined with popup warning messages.
- Detailed memory of temperature / humidity alarms triggered.
- "Test center" mode to check, in a simple and intuitive way, all the digital and analogical inputs/outputs.
- RS485 serial connection with TeleNET or Modbus protocol which can be selected in the parameters.
- Web server: control the Vision Touch from web browsers (controlled access).
- Automatic sending of e-mail in case of alarm.

PRODUCT IDENTIFICATION CODES**1.2****200VT100WEL1**

- TOUCH electronic control dedicated for wellness applications. It has a stylish 7" TFT display with capacitive touch screen combined with a highly advanced software and a highly user friendly interface that allows for easy use.
- 5m telephone cord included.
- 1 NTC probe (1x1.5 m) included. Humidity probe is separate.

1.3

OVERALL DIMENSIONS

Dimensions in mm:

VISION TOUCH



100N MASTER3

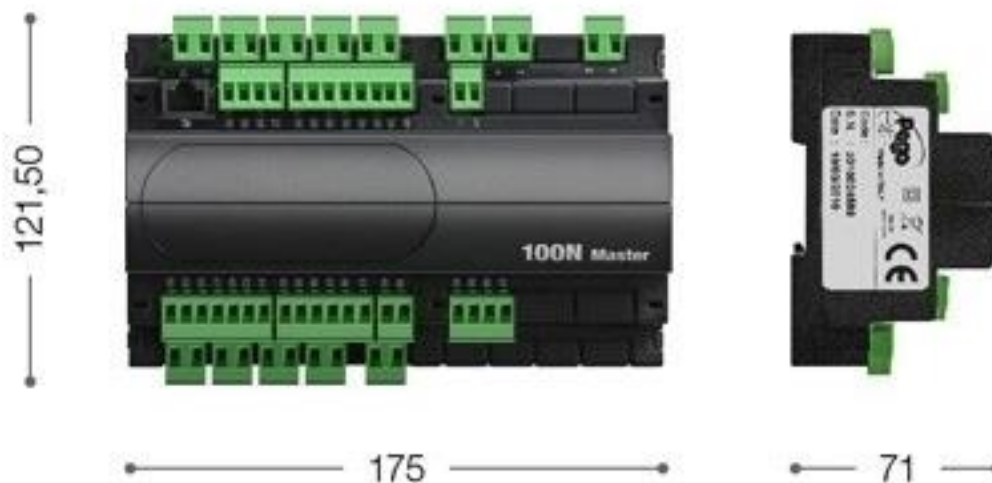







1.4

IDENTIFICATION DATA

The device described in this manual has, on the side of 100N MASTER3 and on the back of the VISION TOUCH WELLNESS console, a plate bearing its identification data:

- Name of Manufacturer
- Description anche code of device
- Serial number of device
- Date of manufacture

 <p>MADE IN ITALY</p> <p>Description: VISION TOUCH WEL Code: 200VTOUCHWEL S.N.: 2017004799 Date: 18/10/2017</p>	 RoHS compliant 	 <p>MADE IN ITALY</p> <p>Description: 100N-MASTER3 Code: 200VT100WEL1 S.N.: 2017005656 Date: 18/10/2017</p>	 RoHS compliant 
---	--	---	--

Power supply			
Voltage	110 - 230 V~ ± 10% 50/60Hz		
Max power consumption (electronic controller only)	~ 15 VA		
Climatic conditions			
Operating temperature	-5 ÷ +50°C		
Storage temperature	-10 ÷ +70°C		
Relative ambient humidity	Less than 90% RH		
General features			
Type of connectable probes (temperature)	NTC 10K 1%		
Resolution (ambient temperature)	0.1°C		
Precision of probe detection (ambient temperature)	± 0,5°C		
Reading range	-45 ÷ +99 °C		
Humidity probe	analogue input 4-20 mA		
Precision of humidity probe detection	see humidity probe features		
Range of humidity probe detection	0-99 rH%		
Output features			
Description	Relay installed	Features of output board	Notes
Output 3-4	(30A AC1 relay)	30A 240V~ (AC1) 10A 240V~ (AC3) (2HP) (100000 cycles)	All the outputs are voltage-free contacts
11 outputs from 5 to 26 (see connections diagram)	(16A AC1 relay)	16A 240V~ (AC1) 3A 240V~ (AC3)	
Dimensional features			
Dimensions 100N MASTER	121.50 mm x 71 mm x 175 mm (HxDxL)		
Dimensions VISION TOUCH	151 mm x 44 mm x 191 mm (HxDxL)		
Insulation and mechanical properties			
Degree of protection of display	IP65		
Material of box	Self-extinguishing ABS		

CHAPTER 2: INSTALLATION

2.1

GENERAL RULES FOR THE INSTALLER

1. If the program is used in applications with the risk of harming persons, machines or materials, it must be coupled with auxiliary alarm devices;
2. The programmer must NOT be installed in environments with dangerous atmospheres (flammable or explosive); it can only be connected to elements which operate in this atmosphere by means of appropriate and suitable types of interface compliant with safety standards in force;
3. Install the appliance in places which respect the degree of protection;
4. Avoid using multi-pole cables with conductors connected to inductive and power conductors and signal conductors like probes and digital inputs;
5. Avoid housing power cables in the same conduits as signal cables (probes, digital or analogue inputs, communication cables)
6. Minimize the length of the connecting cables to prevent these from coiling up and adversely affecting the electronics through induction;
7. All the conductors of the cables must be of an appropriate size to withstand the required load;
8. Place a general protection fuse upstream the electronic controller;
9. Provide a two-phase disconnecting switch compliant with foreseen safety requirements (CE marked) to shut off the power supply upstream the controller. The switch must be placed in the immediate vicinity of the regulator and must be easily reachable by the operator.
10. Should the length of the probes need to be extended, it is necessary to use conductors with an appropriate cross-section and however no less than 1mm². Extension or shortening of the probes may alter the factory settings; use an external thermometer, therefore, for testing and calibration.
11. When using the console at low temperatures there could be a visible slow down in the response from the display; this can be considered normal.

2.2

STANDARD EQUIPMENT FOR ASSEMBLY AND USE

The **VISION TOUCH WELLNESS** electronic controller is provided with the following for assembly and use:

- 1 temperature probe;
- 1 plug telephone cable (5m);
- 1 user quick guide;
- 1 console Vision Touch WELLNESS (200VTOUCHWEL);
- 4 media for Vision Touch console;
- 1 100N MASTER3 (200100NMSTH3);

Fig. 1: Install the 100N MASTER3 module on the DIN guide and close the bottom clamps to hold it in place.

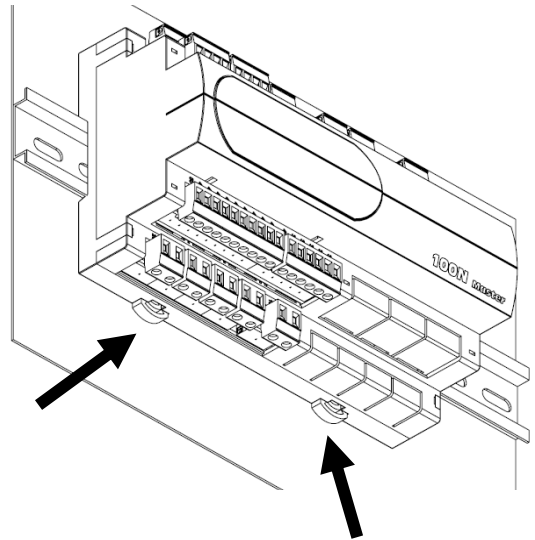

Fig. 2: **VISION TOUCH** console drilling template.

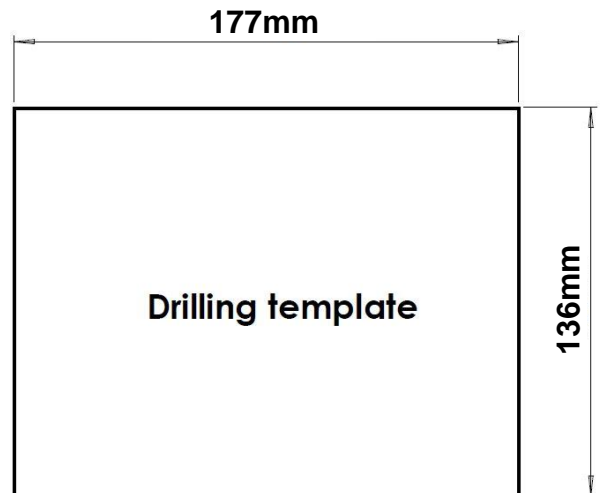

Fig. 3: Configure properly the side switch (if present) to reverse the viewing angle of the display. This allows you to mount the **VISION TOUCH** at any height.

When mounted in the low position, rotate the display by 180° in order to have the signal leds at the top.

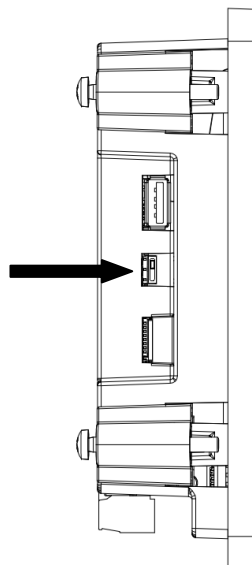
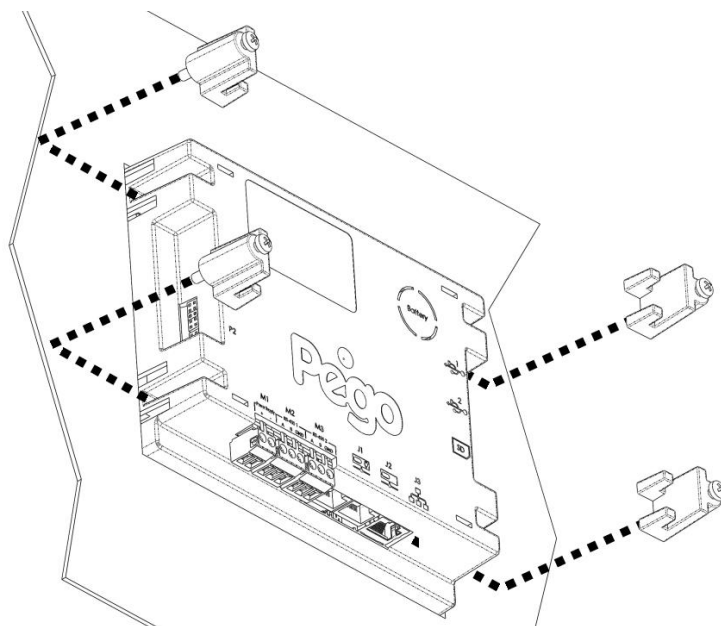

Fig. 4: Fasten the **VISION TOUCH** console by means of the four media to be inserted in their specific seats. Tighten each screw until the entire border front of the console rests on the panel.



CHAPTER 3: ELECTRICAL CONNECTIONS

Following are the electrical connections of the controller divided by type. The configurations of the inputs and outputs shown below are set by default but can be changed to suit your needs. The connection between the console and 100N MASTER3 has two possible variants based on the distance between the two components.

POWER SUPPLY AND CONNECTION CONSOLE / 100N MASTER3

3.1

1) Connection between the console and 100N MASTER3 with distance within 10m:

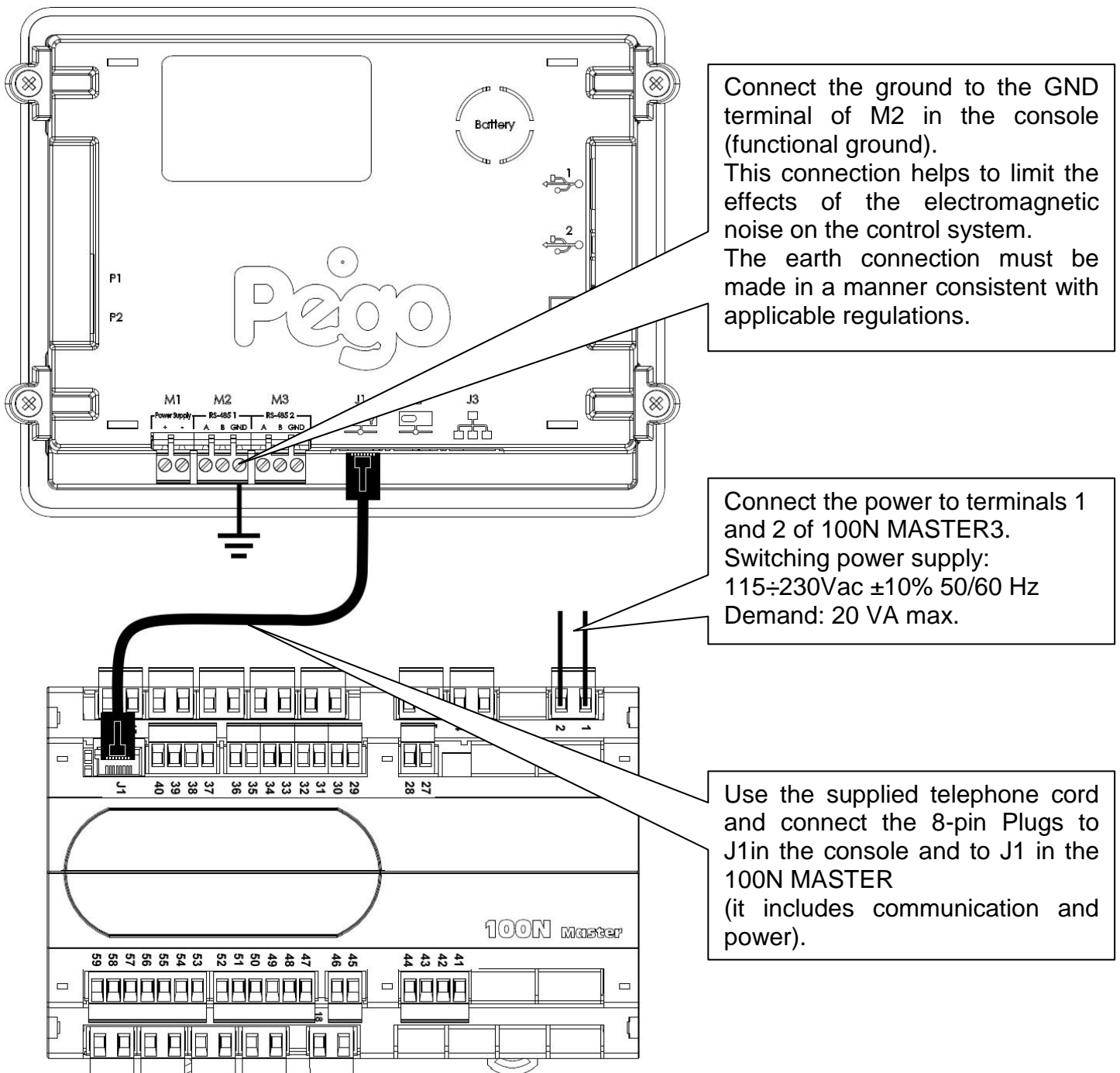

2) Connection between the console and 100N MASTER3 with distance within 500m:

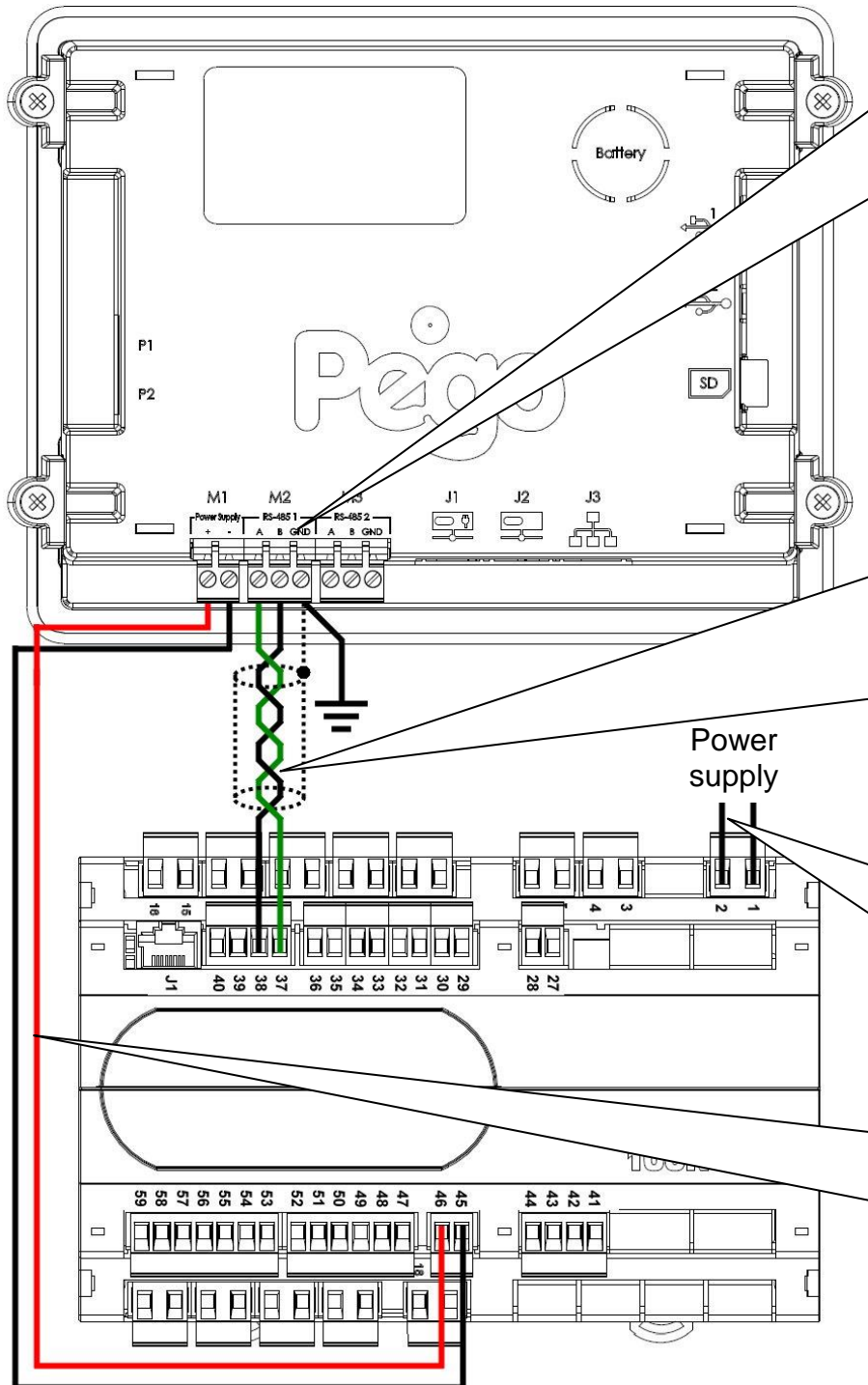

Connect the ground to the GND terminal of M2 in the console (functional ground). This connection helps to limit the effects of the electromagnetic noise on the control system. The ground connection must be made in a manner consistent with applicable regulations.

Connect terminal (1) of M2 in the console to terminal 37 of 100N MASTER3 and term (B) of M2 in the console to terminal 38 of 100N MASTER3. Connect the braid of the shielded cable to the (GND) terminal of M2 in the console. Use twisted cable suitable for the transmission of RS485 signals with minimum section of 0.5mm² (e.g. Belden 8762 cable). Avoid coupling with power cables.

Connect the power to terminals 1 and 2 of 100N MASTER3. Switching power supply: 115÷230Vac ±10% 50/60 Hz Demand: 20 VA max.

Connect terminal (-) of M1 in the console to terminal 45 of 100N MASTER3 and term (+) of M1 in the console to terminal 46 of 100N MASTER3. Avoid coupling with power cables.

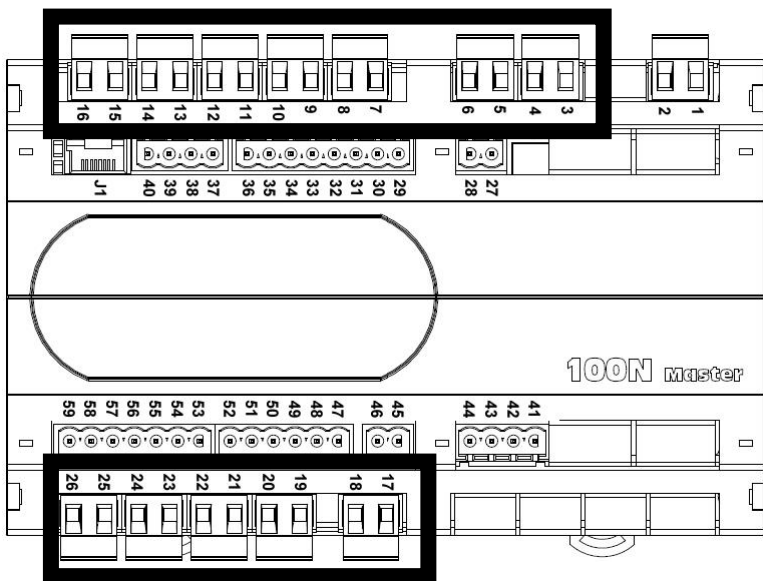









**POSSIBLE CONFIGURATIONS
DIGITAL OUTPUTS DO1÷DO12**

Access menu:

Parameters > Configure I/O > Digital outputs

- 0 = Disabled
- 1 = Hot 1
- 2 = Hot 2
- 3 = Hot 3
- 4 = Fans
- 5 = Humidification
- 6 = Light
- 7 = RGB Light
- 8 = Alarm (only DO12)

Positive values = Contact N.O.
Negative values = Contact N.C.

PIN TERMINALS	DIGITAL OUTPUT	DEFAULT SETTINGS DIGITAL OUTPUTS	RELAY OUTPUT FEATURES (Voltage-free contacts)
3-4	DO1	 1 = Hot 1 (contact N.O)	Relay 30A 240V~ (AC1) 10A 240V~ (AC3) (2HP)
5-6	DO2	 2 = Hot 2 (contact N.O)	Relay 16A 240V~ (AC1) 3A 240V~ (AC3)
7-8	DO3	 3 = Hot 3 (contact N.O)	Relay 16A 240V~ (AC1) 3A 240V~ (AC3)
9-10	DO4	 4 = Fans (contact N.O)	Relay 16A 240V~ (AC1) 3A 240V~ (AC3)
11-12	DO5	 5 = Humidification (contact N.O)	Relay 16A 240V~ (AC1) 3A 240V~ (AC3)
13-14	DO6	 6 = Light (contact N.O)	Relay 16A 240V~ (AC1) 3A 240V~ (AC3)
15-16	DO7	 7 = RGB Light (contact N.O)	Relay 16A 240V~ (AC1) 3A 240V~ (AC3)
25-26	DO8	0 = Disabled	Relay 16A 240V~ (AC1) 3A 240V~ (AC3)
23-24	DO9	0 = Disabled	Relay 16A 240V~ (AC1) 3A 240V~ (AC3)
21-22	DO10	0 = Disabled	Relay 16A 240V~ (AC1) 3A 240V~ (AC3)
19-20	DO11	0 = Disabled	Relay 16A 240V~ (AC1) 3A 240V~ (AC3)
17-18	DO12	 12 = Alarm (contact N.O)	Relay 16A 240V~ (AC1) 3A 240V~ (AC3)

3.3 DIGITAL INPUT CONNECTION ON 100N MASTER3

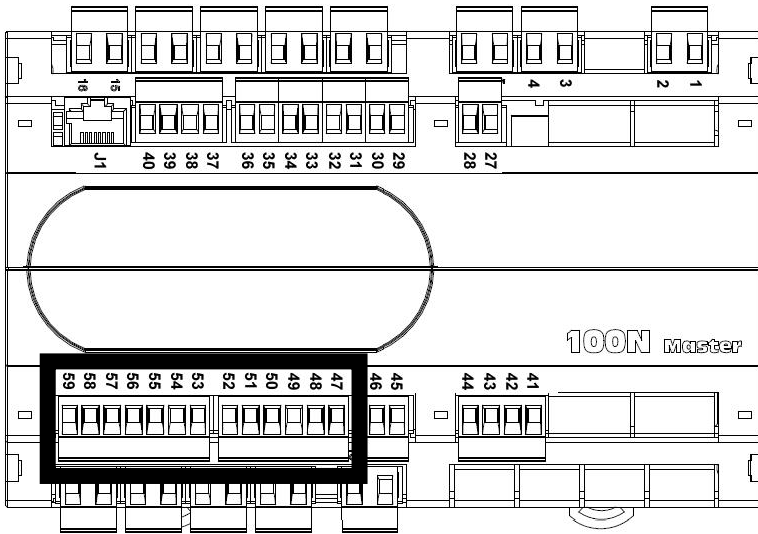









POSSIBLE CONFIGURATIONS
DIGITAL INPUTS DI1÷DI12

Access menu:
Parameters > Configure I/O > Digital inputs

- 0 = Disabled
- 1 = Alarm
- 2 = Stand-by
- 3 = Disable hot
- 4 = Disable humidity
- 5 = Humidifier alarm
- 6 = Fans protection
- 7 = Generic Warning 1
- 8 = Generic Warning 2
- 9 = Generic Warning 3

Positive values = Contact N.O.
Negative values = Contact N.C.

PIN TERMINALS	DIGITAL INPUT	DEFAULT SETTINGS DIGITAL INPUTS (Use voltage-free contacts)	
		Icon	Description
47-59	DI1		-1 = Alarm (function Not active with contact N.C.)
48-59	DI2		2 = Stand-by from remote (function Not active with contact N.O.)
49-59	DI3		3 = Disable hot (function Not active with contact N.O.)
50-59	DI4		4 = Disable humidity (function Not active with contact N.O.)
51-59	DI5		5 = Humidifier alarm (function Not active with contact N.O.)
52-59	DI6		6 = Fans protection (function Not active with contact N.O.)
53-59	DI7		7 = Generic Warning 1 (function Not active with contact N.O.)
54-59	DI8		8 = Generic Warning 2 (function Not active with contact N.O.)
55-59	DI9		9 = Generic Warning 3 (function Not active with contact N.O.)
56-59	DI10		0 = Disabled
57-59	DI11		0 = Disabled
58-59	DI12		0 = Disabled

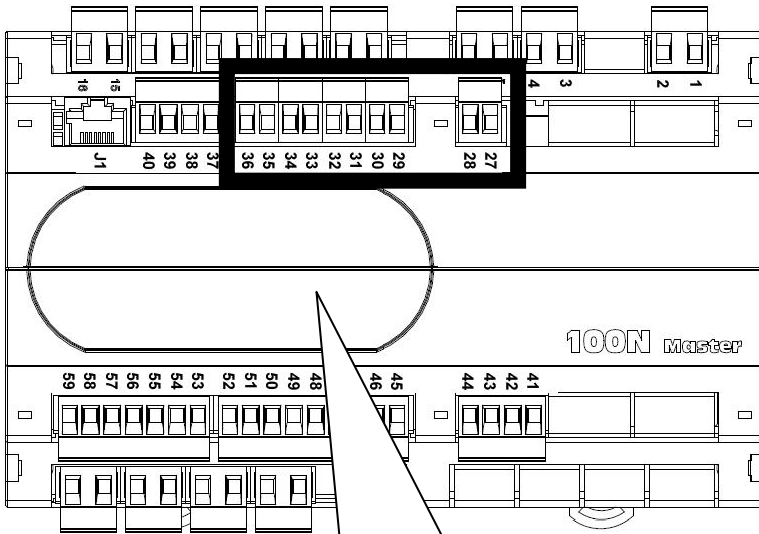

POSSIBLE CONFIGURATIONS
ANALOGUE INPUTS AI1 ÷ AI5

Access menu:
Parameters > Configure I/O > Analogue inputs

0 = Disabled
1 = Ambient temperature (NTC)
2 = Ambient humidity probe (4-20mA)

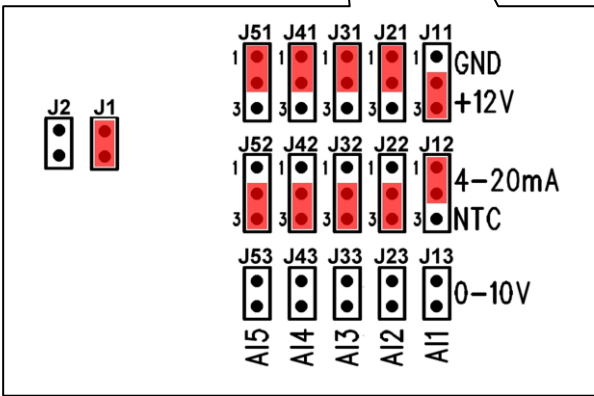

The selection of the desired function for each analogue input is done by the configuration of the dedicated parameter in the “Parameters > Configure I/O > analogue inputs” menu combined with the correct setting of the Hardware configuration jumpers on the 100N MASTER3 under the removable front cover (see the side image).

In particular, the configuration is as follows:
For NTC probes: J*1=1-2, J*2=2-3, J*3=open
For 4-20mA probes: J*1=2-3, J*2=1-2, J*3=open
*= number analogue input

PIN TERMINALS	DESCRIPT. TERMINALS	TYPE OF SIGNAL	ANALOGUE INPUT	DEFAULT SETTINGS ANALOGUE INPUTS	DEFAULT SETTINGS BRIDGES ON 100N MASTER3
27	RH	4-20mA	AI1	2 = Ambient humidity probe	J11 = 2-3
28	V+				J12 = 1-2
29		NTC	AI2	1 = Ambient temperature	J21 = 1-2
30					J22 = 2-3
31		NTC	AI3	0 = Disabled	J31 = 1-2
32					J32 = 2-3
33		NTC	AI4	0 = Disabled	J41 = 1-2
34					J42 = 2-3
35		NTC	AI5	0 = Disabled	J51 = 1-2
36					J52 = 2-3
					J53 = open

3.5 ANALOGUE OUTPUT CONNECTION ON 100N MASTER3

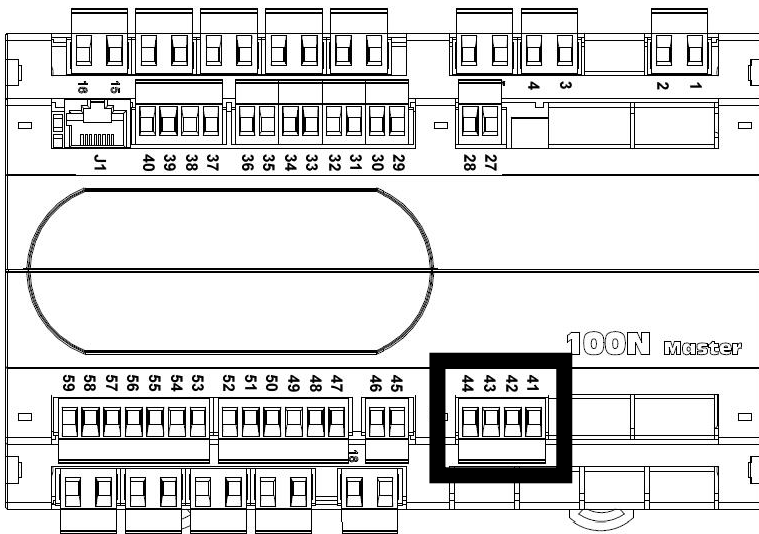

**POSSIBLE CONFIGURATIONS
ANALOGUE OUTPUTS AO1÷ AO3**

Access menu:
Parameters > Configure I/O > analogue outputs

0 = Disabled
 1 = RGB light control - red
 2 = RGB light control - green
 3 = RGB light control - blue

PIN TERMINALS	DESCRIPT. TERMINALS	TYPE OF SIGNAL	ANALOGUE OUTPUT	DEFAULT SETTINGS ANALOGUE OUTPUTS
41	Ref.	0-10V	AO1	1 = RGB light control – red
44	Gnd			
42	Ref.	0-10V	AO2	2 = RGB light control – green
44	Gnd			
43	Ref.	0-10V	AO3	3 = RGB light control – blue
44	Gnd			

3.6 ETHERNET CONNECTION ON VISION TOUCH

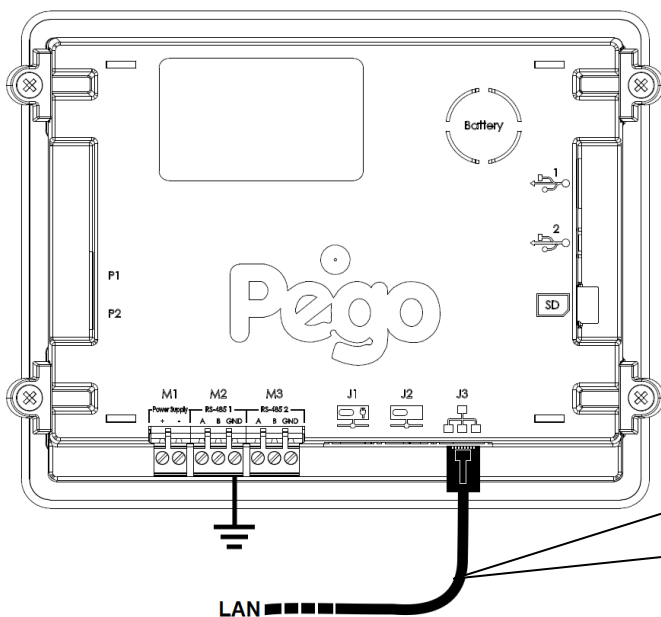

Connect the Ethernet cable with RJ45 connector to the J3 input of the Vision Touch console. Connect the other end of the cable to the existing LAN or to the PC.

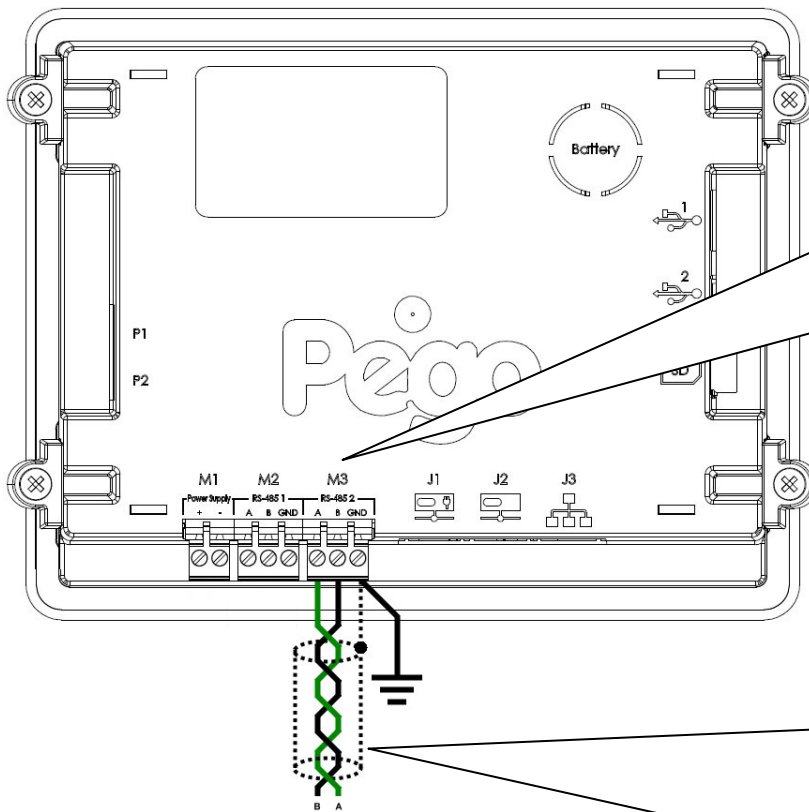

Connect the earth to the GND terminal of M3 in the console (functional earth). This connection helps to limit the effects of the electromagnetic noise on the control system. The ground connection must be made in a manner consistent with applicable regulations.

Connect the terminal (A) of M3 in the console to signal A of the Modbus line and the terminal (B) of M3 in the console to signal B of the Modbus line. Connect the braid of the shielded cable to the terminal (GND) of M3 in the console.

Use twisted cable suitable for the transmission of RS485 signals with minimum section of 0.5mm² (e.g. Belden 8762 cable). Avoid coupling with power cables.

1) Example of connection between the console and the Modbus line:

It is recommended to connect a resistor equal to 120Ω between A and B at the beginning and end of the line in case of communication problems. For a correct functioning the Master has to have a RS485 polarized.

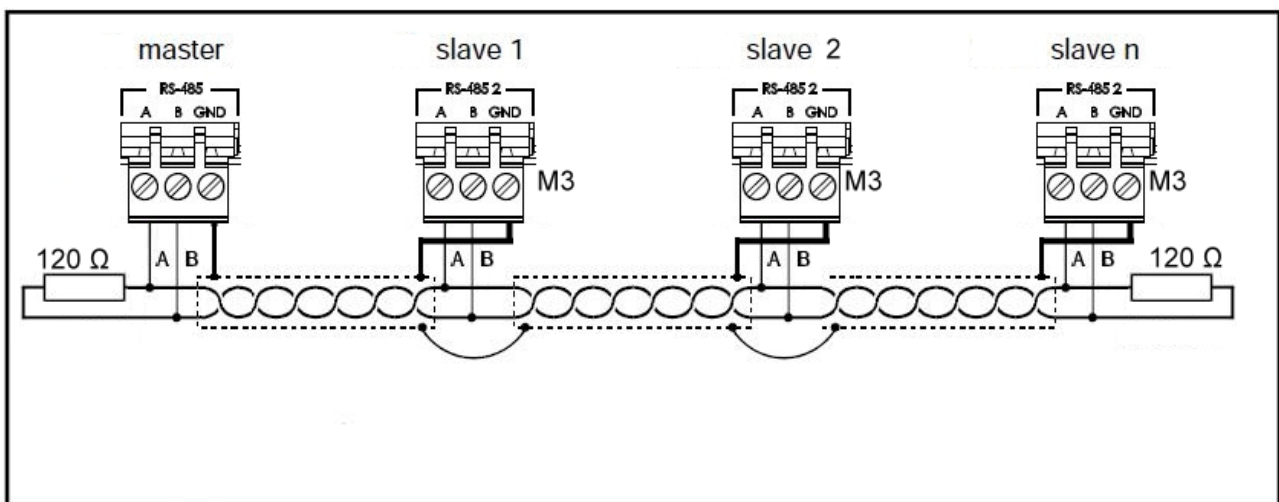

CHAPTER 4: SWITCHING ON

4.1 COMMISSIONING

When the controller is switched on for the first time, the "Language Selection" and "time and date setting" pages of the system are displayed to facilitate the user in starting up the controller. These settings can even be modified further on by means of the "Language" and "Date and time" items within the "Parameters" menu.

Set the language by pressing these buttons.

Confirm the settings by pressing the confirmation button.

Set the date and time by scrolling your finger over the digits from the top downwards.

Confirm the settings by pressing the confirmation button.

Automatic date and time synchronization via the Web (required ethernet connection)

Every time the controller is switched on, an information pop-up is displayed with the starting date and time, requesting the user to acquire the information by pressing "OK". This allows to verify the return from an electrical blackout.



The start-up event is also memorized inside the "alarms" menu to make it possible to verify this information over time.



CHAPTER 5: USER INTERFACE

This section illustrates the features and instructions for using the display, the light indicators and the buttons making up the user interface of the VISION TOUCH WELLNESS, and therefore represent an essential requirement to correctly program and configure the controller.

5.1

CONSOLE FUNCTIONAL ZONES

The display is divided into 3 main parts:

- **Main display:** interactively displays the various home pages and menu items.
- **Status bar:** it is divided into 3 parts and displays the following data:
 - in the middle: description of current visualization of main display.
 - on the right: current date/time, presence of USB key, or access as installer.
- **Button bar:** views the main operating buttons and their status.

At the bottom in the middle there are two LEDs:

Green LED: Flashing = controller in stand-by / On fixed = Controller powered

Red LED: Flashing = controller in Alarm



The section of the main display views the work and setting pages based on the position (for example Home, RGB). A detailed description of the various pages will be made further on in this manual.

The Status Bar is in the lower part of the display (above the Button Bar, if applicable) and displays some important information relating to the status of the device, such as the description of the currently displayed page. It is always present except when, in some rare cases, it is temporarily hidden to fully exploit the display.

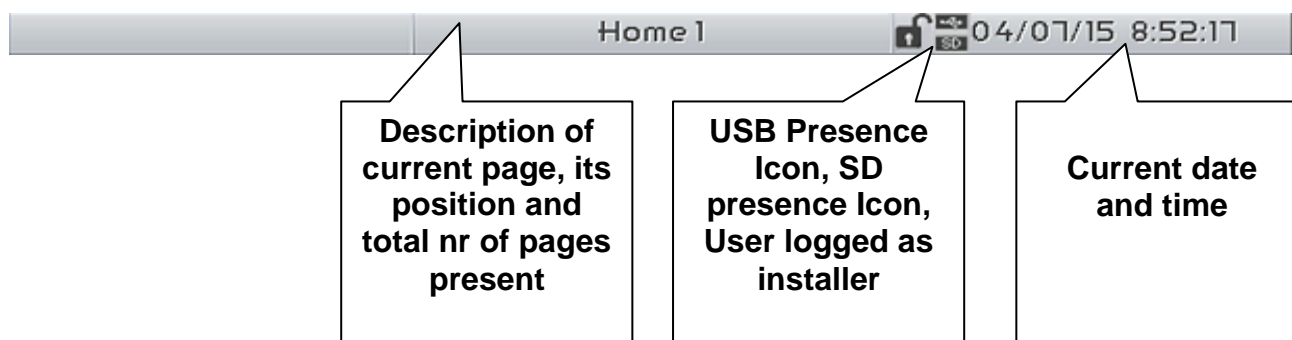

5.4

BUTTON BAR

The Button Bar is at the bottom of the display and views the main operating buttons and their status. It is always present except when, in some rare cases, it is temporarily hidden to fully exploit the display.



The buttons can have different shapes but always include an icon, a description and the colour identifying the status.

In particular, the colour code of the buttons is the following:



BLUE:
Button which can be enabled



GREY:
Button not active (Disabled)



GREEN:
Button function activated or Confirmation button



YELLOW:
Cancel button



RED:
Alarm triggered indication or File elimination button



ORANGE:
Indication of alarm no longer triggered but yet to be acquired

Some buttons have delayed activation to avoid unintentional commands (see standby for example). When pressed the progressive colour change is viewed until the function is activated.

Description of buttons in Button Bar:



BACK:

Inside a menu or level: Go back to previous level or menu.
 In a HOME page: Go back to the previous Home page.
 If held for longer than 3 seconds: Go back to HOME 1 page



PARAMETERS: Enter the parameter setting menu



ALARMS: Enter the alarm log menu

Red: Alarm triggered
 Orange: Alarm over but yet to be acquired
 Blue: No Alarm triggered or to be acquired

If the alarm log menu contains only items already acquired (shown in black) a waste bin will appear inside this button indicating the possibility of cancelling the entire log.



HELP: Access the Help page that contains all the information about the manufacturer/installer of the instrument. The data on this page may be modified by a user who is logged in as an installer.



MANUAL AIR RENEWAL: Activates a manual air renewal or deactivates an automatic or manual one in progress. (delayed start)

Green: Air renewal active
 Blue: Air renewal not active



MANUAL LIGHT BUTTON: Manually activates/deactivates the light.

Green: Light active
 Blue: Light not active



MANUAL RGB LIGHT BUTTON: Manually activates/deactivates the RGB light.

Green: RGB light active
 Blue: RGB light not active



STANDBY BUTTON: Activates/deactivates the standby status (delayed start)

Green: Standby active (System OFF)
 Blue: Standby not active (System ON)



EXTENDED BUTTON BAR OPENING BUTTON:

Opens or closes the EXTENDED BUTTON BAR that allows access to additional buttons.

5.5

GESTURE

The Vision Touch, aside from normal pressing of keys, on some pages supports gestures which allow the user a more natural and therefore simpler interaction.

Change Home Page: On one Home page, move your finger to the left or to the right to pass from one Home page to the next one or to the previous one.

Note: it is also possible to move inside the Home pages by pressing the Back button. The middle of the status bar has the description of the page currently displayed.

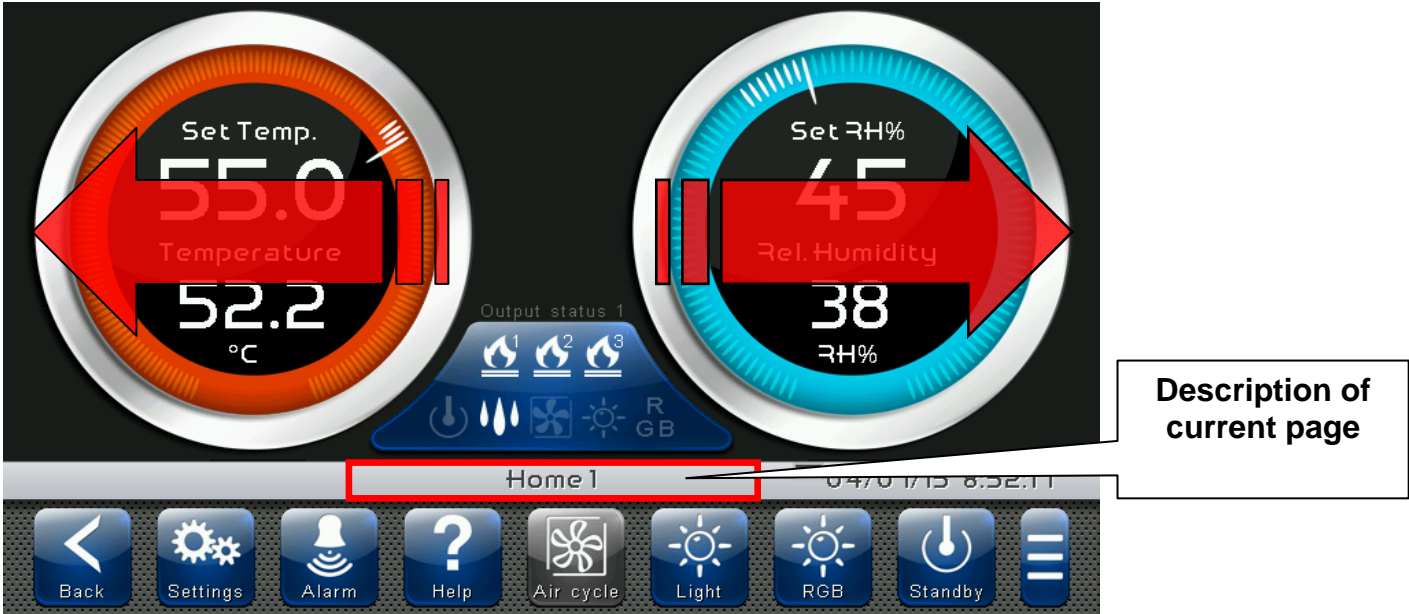

Change Page of a table or parameter list: Move your finger up or down to pass to the next or previous data page.

The middle of the status bar has the description of the page currently displayed, its position and the total number of pages displayable

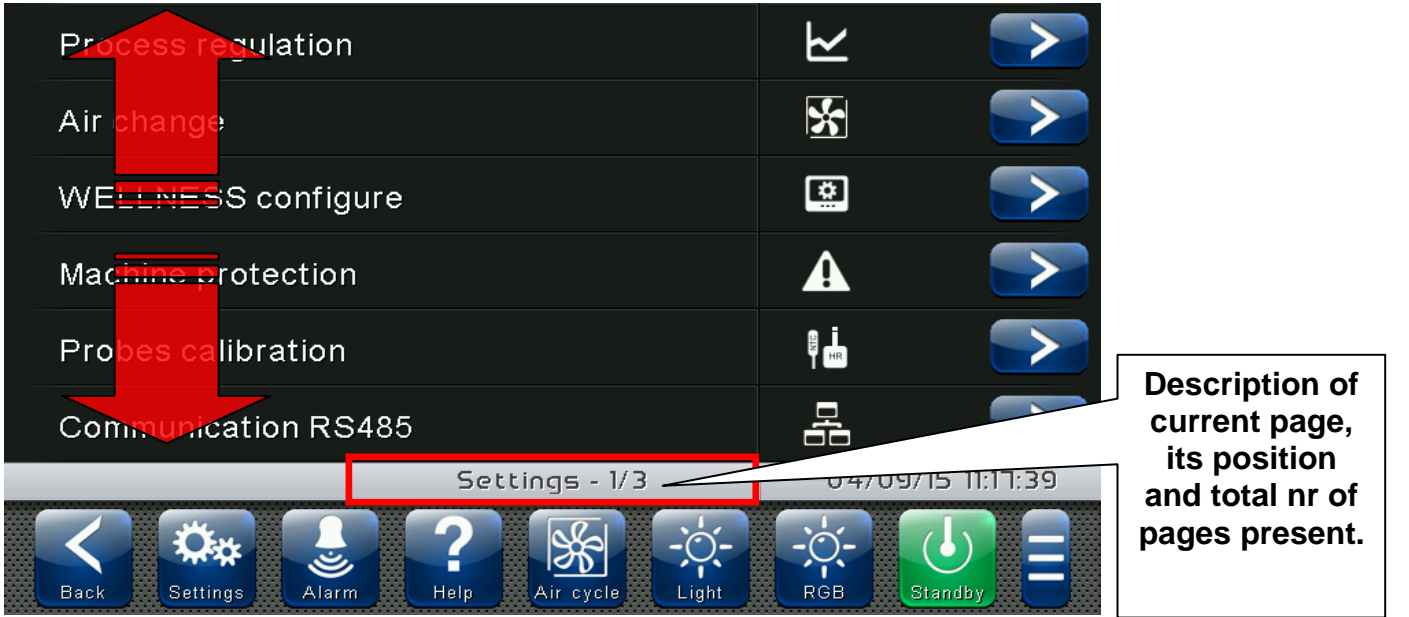

Change parameters with roll selection: Move your finger up or down by one roll to change its value. (Suggestion: move your finger starting from the outside of the roll and pass through it completely).

If the value you are trying to set is not allowed and is not included in the range of the variables, the background of the roll will turn red for an instant indicating that the action is not allowed.



Changing parameters with a switch: Move your finger to the right or to the left to activate or deactivate a switch.

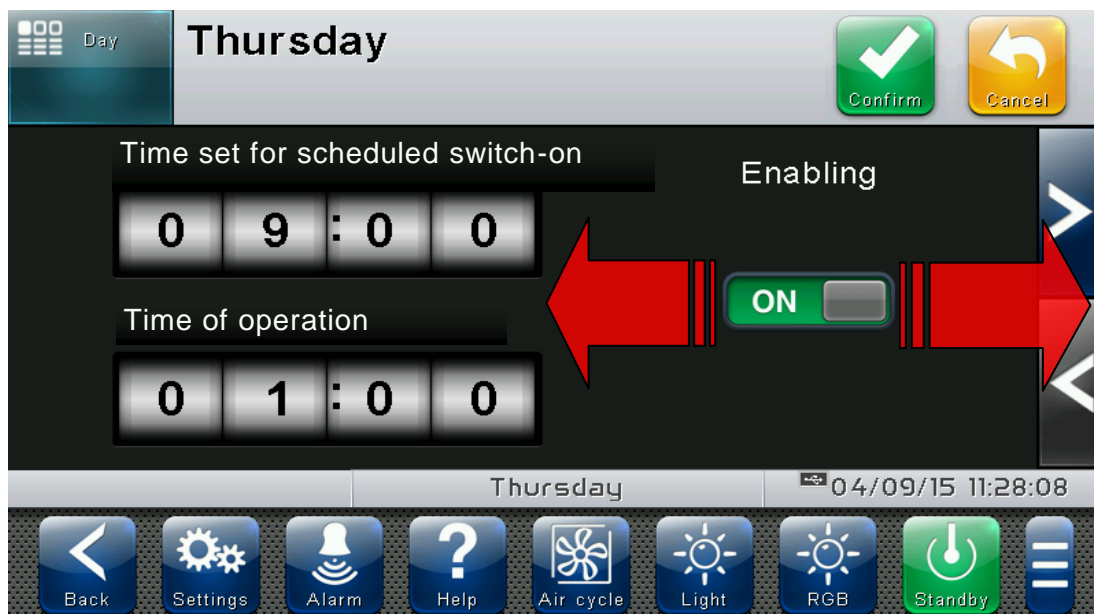

Selection of parameters with Flags: press the flag to change the status or to select one of the possible options.

"Edit" mode in Home 1, 2 and RGB pages: When you are on one of the Home pages, touch the screen at a point which is not a button for more than three straight seconds to enter edit mode of the page itself. To exit this mode, press the "Back" button or wait for the automatic exit after one minute of inactivity.

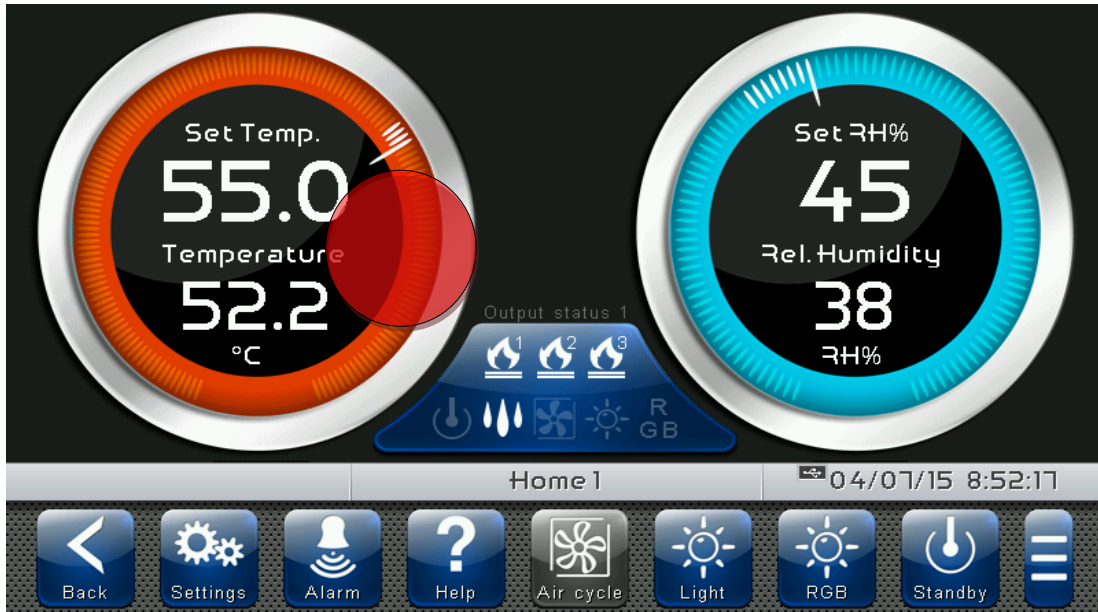

Edit Home 1 Page, Change Set Point with Wheel: Once you have entered edit mode on Home 1, it is possible to change the humidity and temperature Set Points currently in use. The variations are temporary and do not alter the preset program. Turn clockwise to increase or anti-clockwise to decrease the value of the Wheel of the Set Point to be modified or else act on the plus or minus buttons. Then confirm the new values by pressing the green confirmation button.

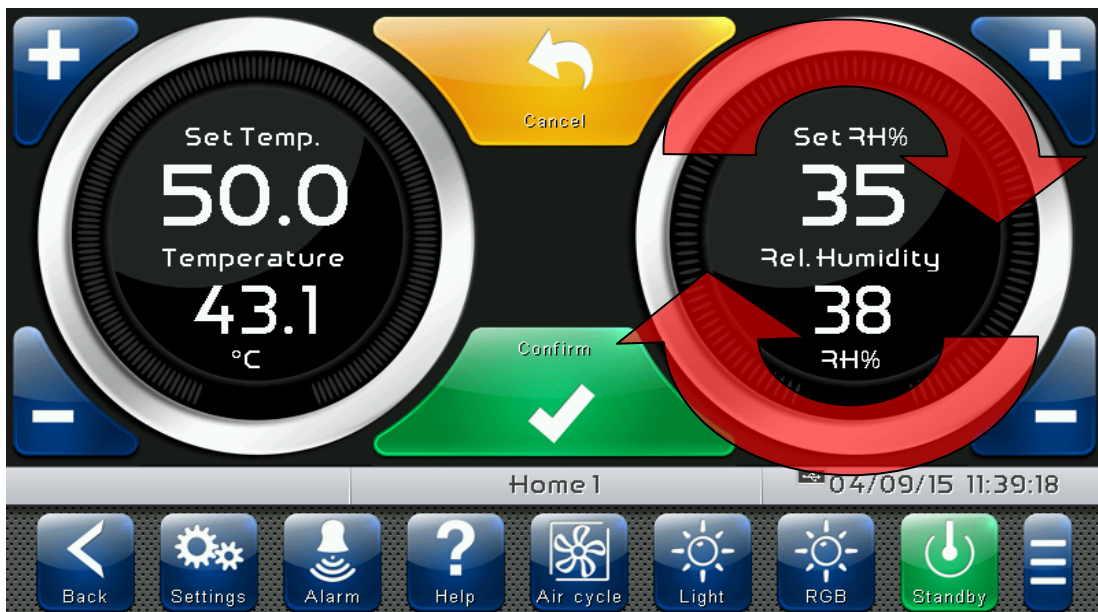

CHAPTER 6: HOME PAGES

The "Home" pages are the main interface of the controller from whence it is possible to access the mostly used features. They are divided as follows:

HOME 1

Display/modify the temperature and humidity setpoints.

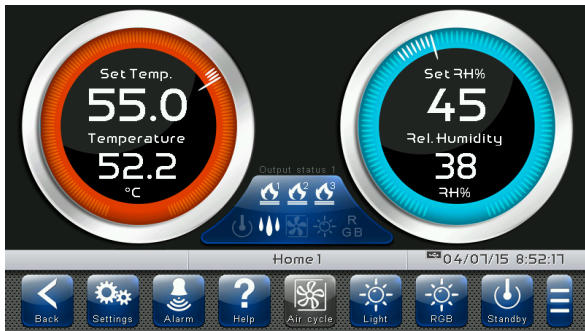

CHROMOTHERAPY

Viewing and changing the configuration of the colour of the RGB light.

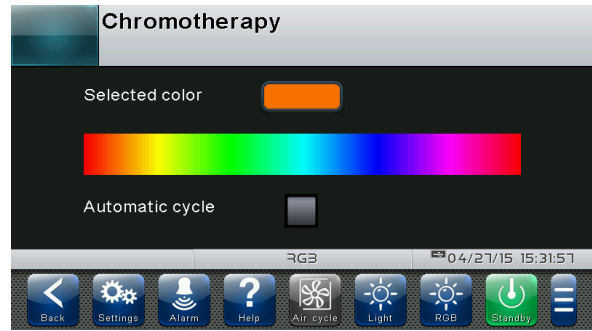

PROGRAMMABLE THERMOSTAT (visible if parameter EnC=1)

Display weekly operating program and modification of the switch-on times and operating times.



SCHEDULED SWITCH-ON (visible if parameter EnC=0)

Display and modification of the scheduled switch-on time or current operating time.



6.1 HOME 1 – Temperature / Humidity, I/O status management

“Home 1” allows to view and modify Temperature and Humidity settings, to visualize the digital input/output statuses and the remaining operating time.

When in visualization, it is divided into 3 main sections:

- Temperature adjustment dial.
- Humidity adjustment dial.
- Multifunction data visualization dial.

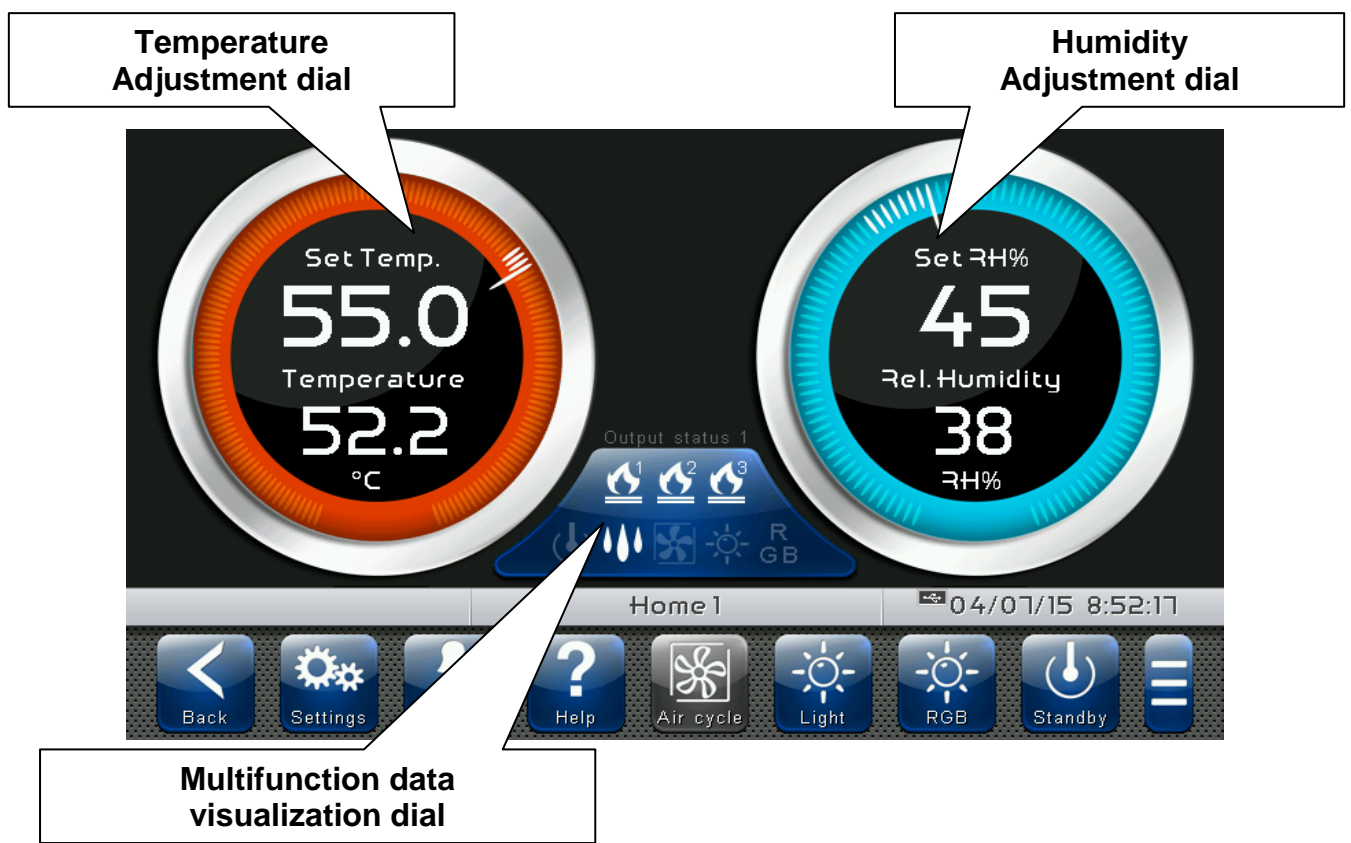

Temperature adjustment dial: Displays all that regards temperature adjustment, in particular:

- The temperature set point (can be modified by pressing the dial for 3 seconds).
- Adjustment probe temperature measurement.
- The status of the call (Hot / No call).

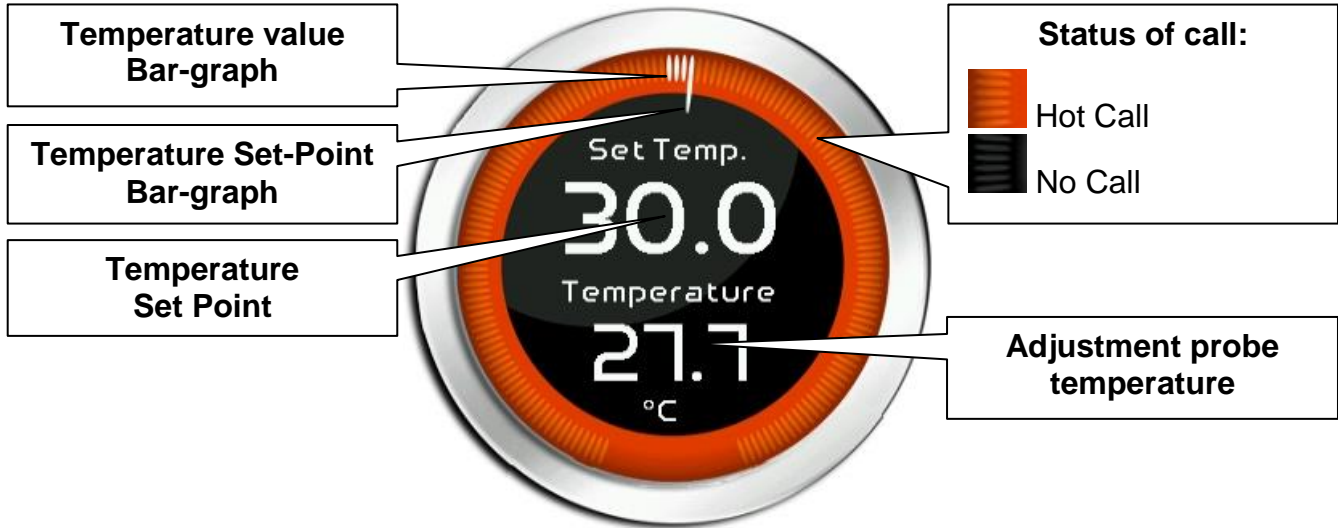





















Humidity adjustment dial: Displays all that regards humidity adjustment, in particular:

- The humidity set point (can be modified by pressing the dial for 3 seconds).
- Adjustment probe humidity measurement.
- The status of the call (Humidify / No call).



Multifunction data visualization dial: it consists of two parts which, when touched, cyclically alternate the data displayed. The following are the various screens and their related meanings. Note: Some data is only viewed if the relative function is enabled in the configuration parameters.

<p>DIGITAL OUTPUT 1 STATUS (Always visible)</p> 	<ul style="list-style-type: none">  Hot 1  Hot 2  Hot 3  Stand-by  Humidify  Air change  Light  RGB Light
<p>DIGITAL INPUT 1 STATUS (Always visible)</p> 	<ul style="list-style-type: none">  Disable heat remotely  Disable humidity remotely  Standby remotely  Generic alarm remotely  Fans protection  Humidifier alarm
<p>DIGITAL INPUT 2 STATUS (Always visible)</p> 	<ul style="list-style-type: none">  Generic Warning 1  Generic Warning 2  Generic Warning 3
<p>REMAINING OPERATING TIME (Visible if not in standby)</p> 	<p>This dial is only displayed when the adjustment is active.</p>

"Set point edit" mode on Home 1 page:

Touch one of the adjustment dials on the screen (Temperature or humidity) for more than three consecutive seconds.

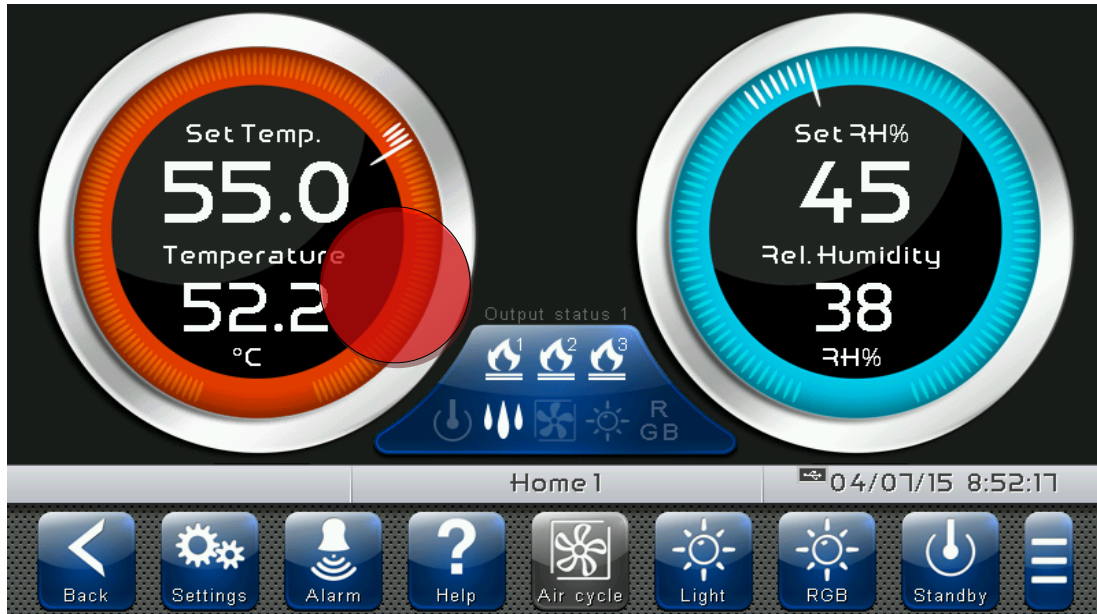

Once you have entered the edit mode, it is possible to change the humidity and temperature Set Points currently in use by rotating the Wheel clockwise to increase or anti-clockwise to decrease the value of the Set Point to be modified. Otherwise you can press the plus and minus buttons. Then confirm the new values by pressing the green "Confirm" button or by pressing "Cancel" to go back to the display screen.

To exit this mode, you can also press the "Back" button or wait for the automatic exit after one minute of inactivity.

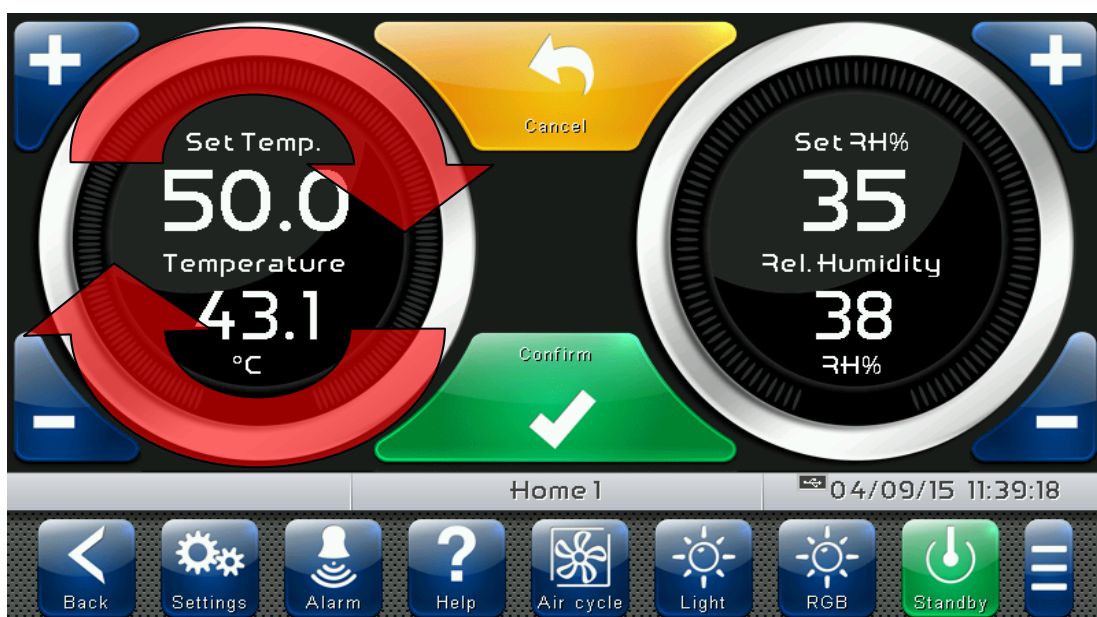

The home "RGB" allows the configuration of the coloured light to be displayed and modified. The bar at the centre of the page indicates the range of selectable colours; an automatic colour variation can be enabled.

"RGB edit" mode on RGB page:

Touch the screen for more than three consecutive seconds.

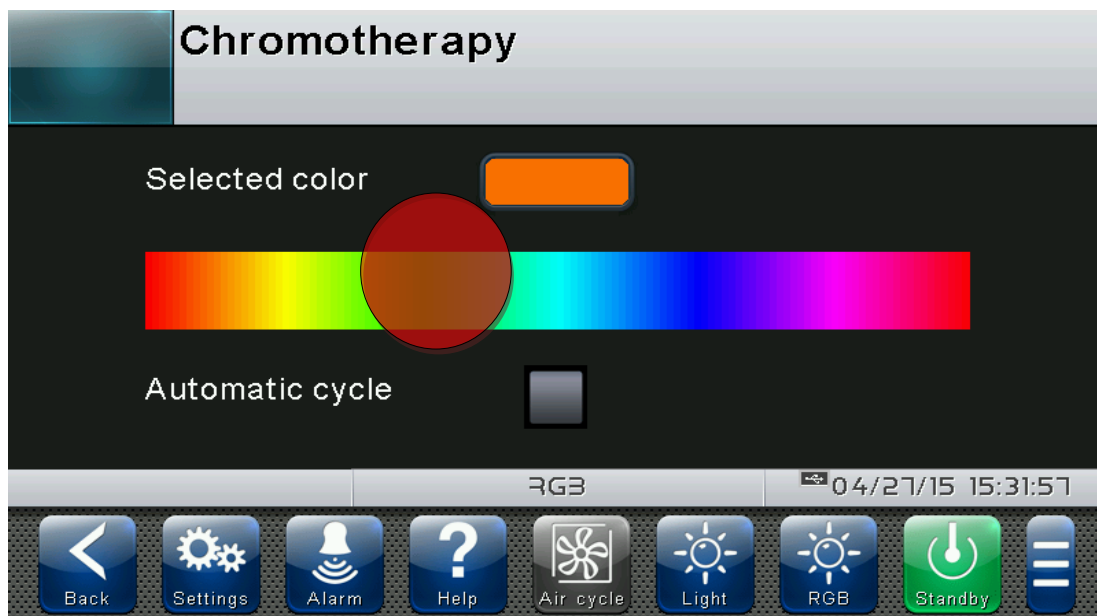

Once in edit mode, you can manually select the colour by touching the adjustment bar or enabling/disabling the automatic colour rotation. To exit this mode, you can also press the "Back" button or wait for the automatic exit after one minute of inactivity.

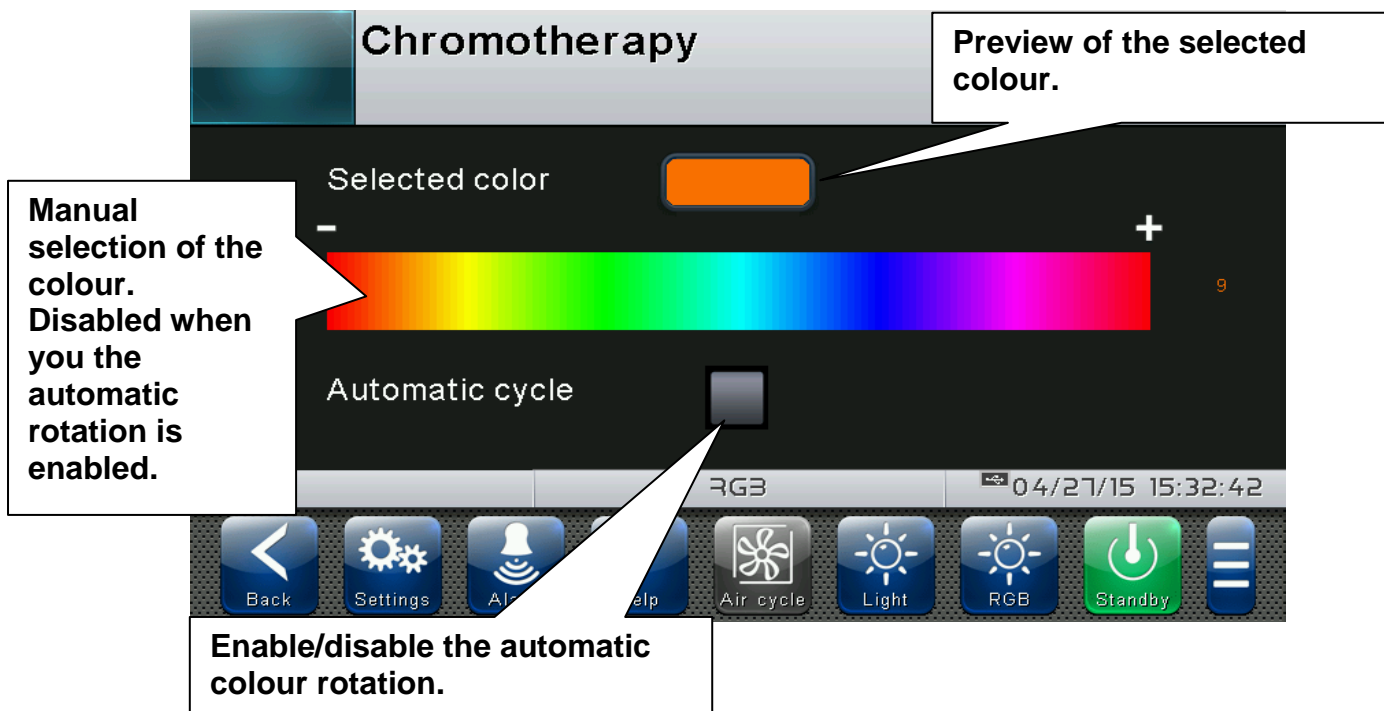

"Home 2" allows the scheduled switch-on to be configured; the graphics and management depends on the value of the EnC parameter and the operating status.

If the programmable thermostat function is disabled (parameter EnC=0) and the adjustment is off (standby), a switch-on time can be set on the "Home 2" page.

"Switch-on time edit" mode on the Home 2 page:

Touch any part of the Home 2 screen for more than three consecutive seconds.

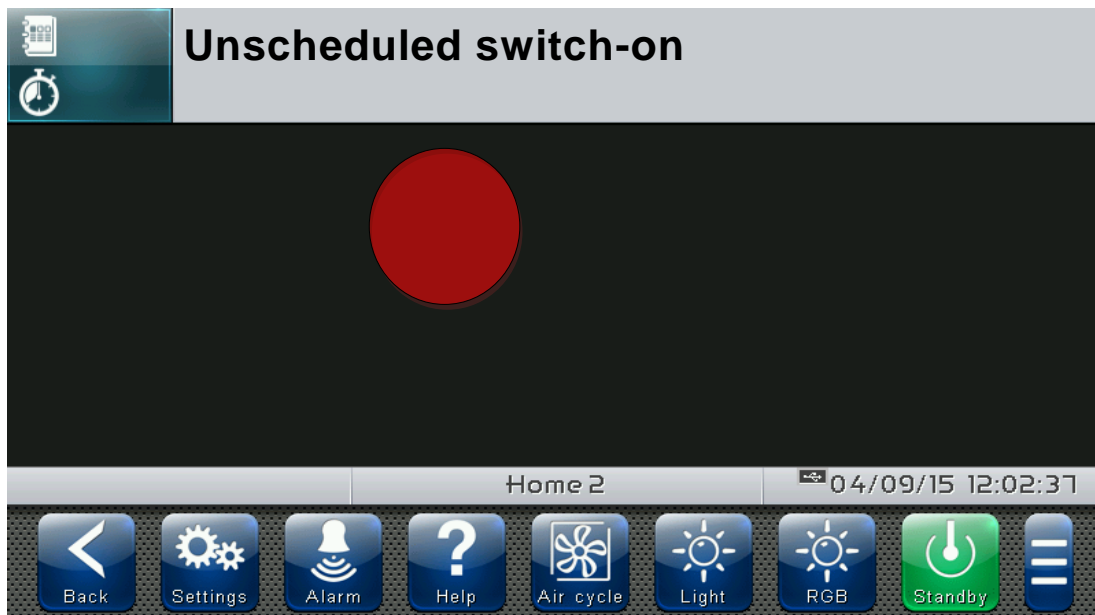

Once the edit mode is accessed, the scheduled switch-on time can be enabled and changed. Then confirm the new value by pressing the green "Confirm" button or by pressing "Cancel" to go back to the display screen.

To exit this mode, you can also press the "Back" button or wait for the automatic exit after one minute of inactivity.

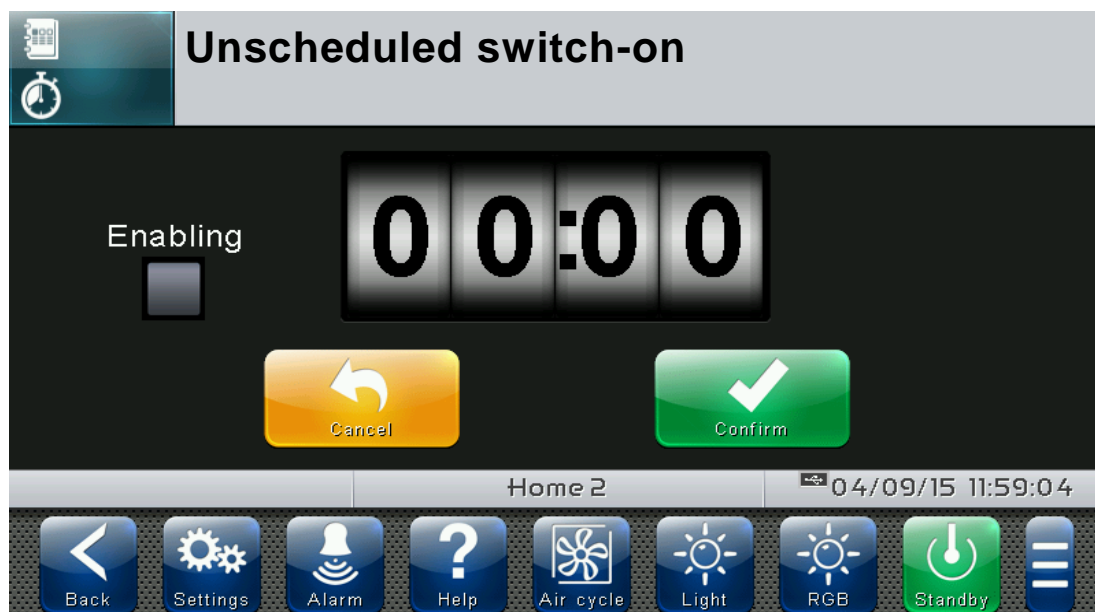

If the programmable thermostat function is disabled (parameter EnC=0) and the adjustment is on (standby), a switch-off delay can be set on the "Home 2" page.

"Switch-off delay edit" mode on the Home 2 page:

Touch any part of the Home 2 screen for more than three consecutive seconds.

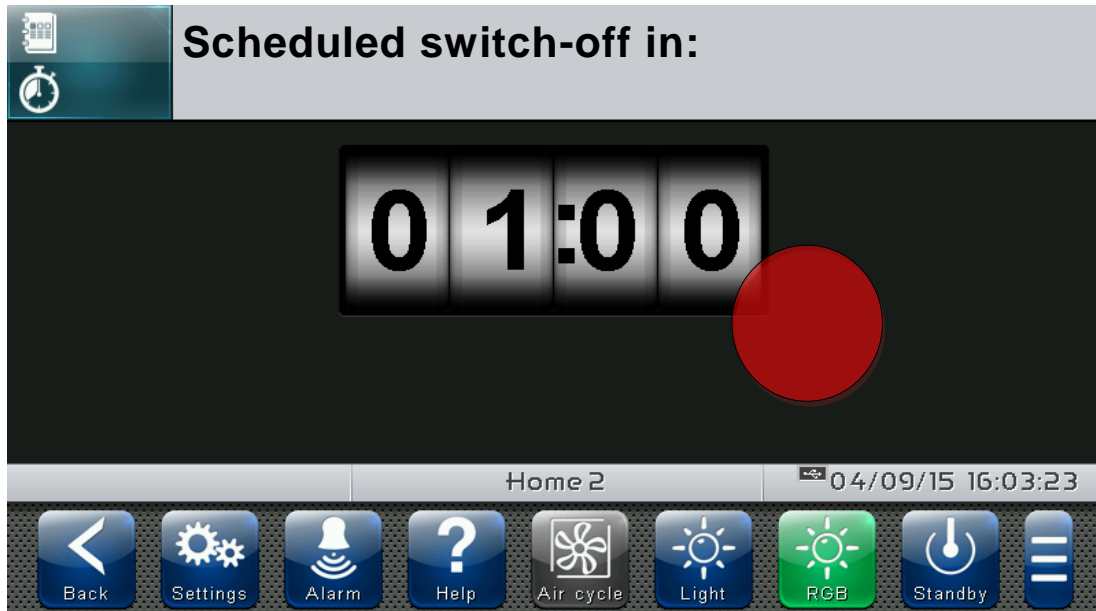

Once the edit mode is accessed, the remaining time for switch-off can be changed. Then confirm the new value by pressing the green "Confirm" button or by pressing "Cancel" to go back to the display screen.

To exit this mode, you can also press the "Back" button or wait for the automatic exit after one minute of inactivity.

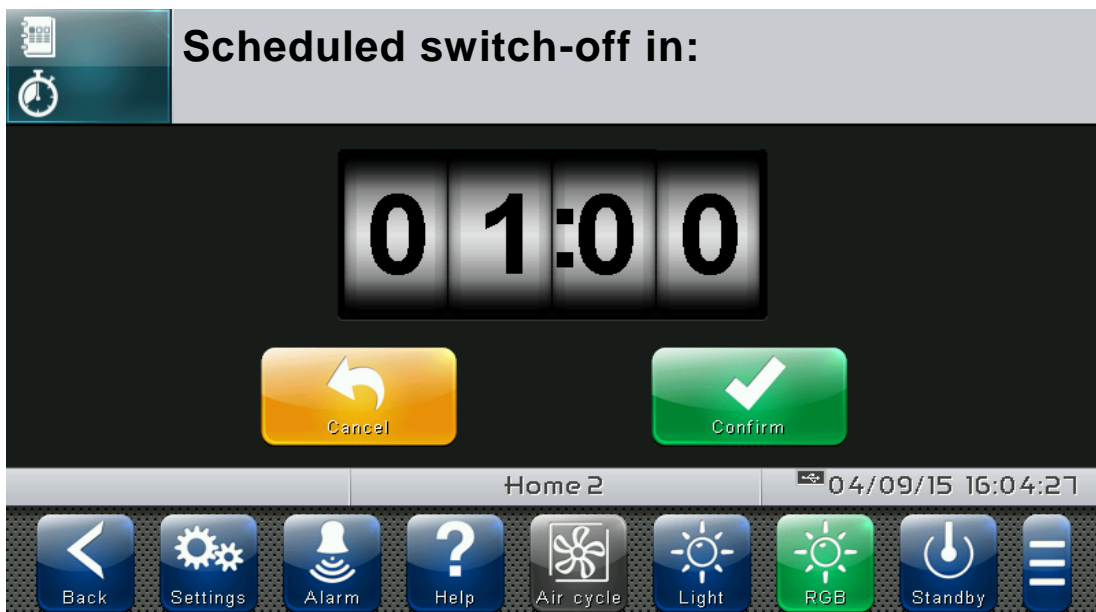

If the programmable thermostat function is disabled (parameter EnC=1) the switch-on times can be set on the "Home 2" page.

The columns indicate the specific settings for each day of the week; the current day is highlighted by a background with grey side bars. If one phase is in progress, the relative start time and duration turn green.

"Programmable thermostat" mode on the Home 2 page:

Touch any part of the Home 2 screen for more than three consecutive seconds.

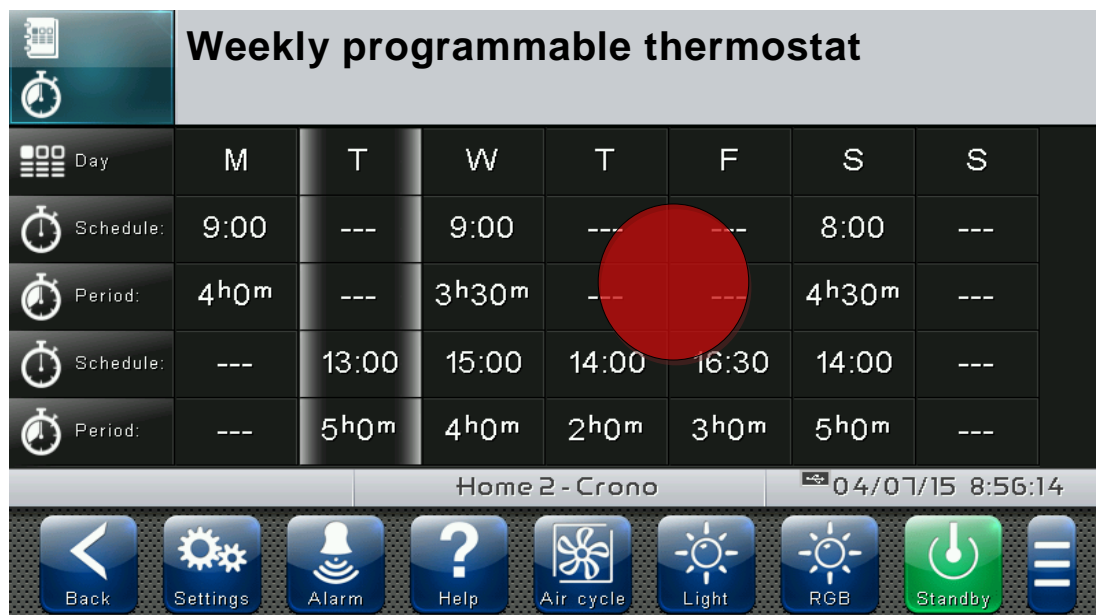

To exit this mode, you can also press the "Back" button or wait for the automatic exit after one minute of inactivity.

Entering edit mode in Home 2, the following screen appears:

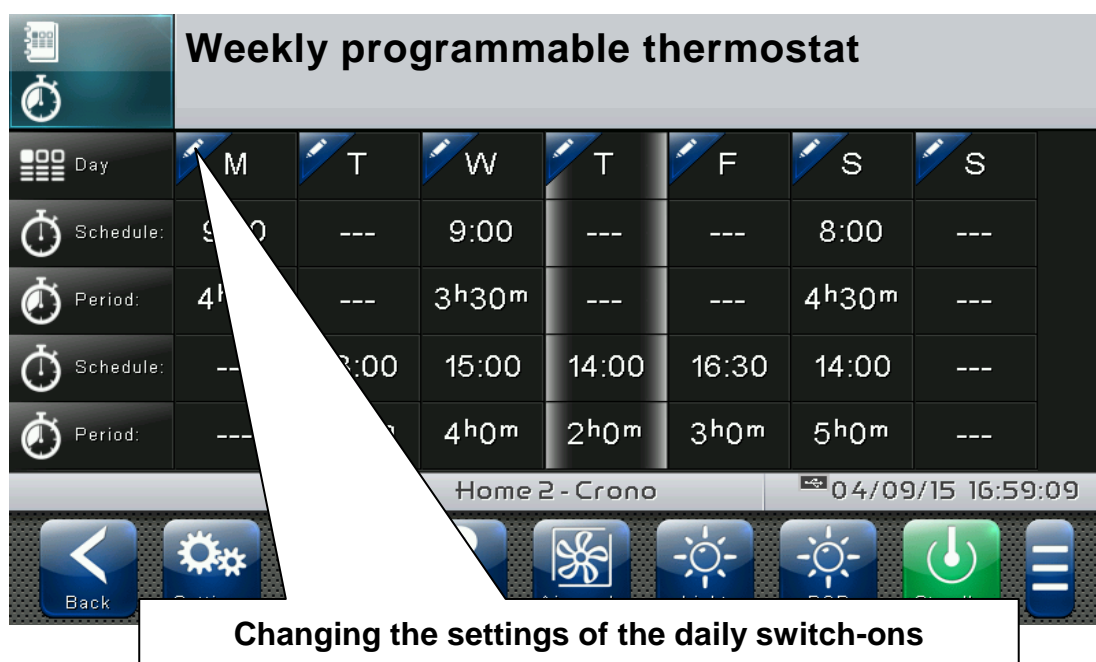

By pressing the button  at the top left of each column you enter a group of two option configuration pages relative to the selected day.

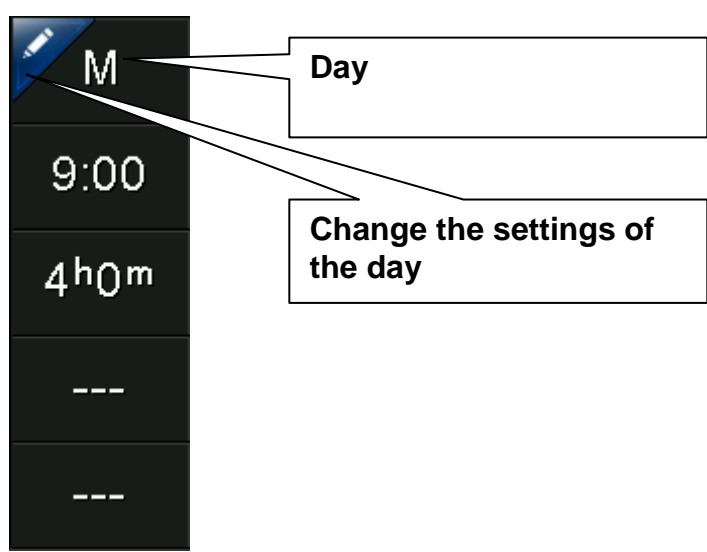

Day configuration page 1/2:

Selected day

Confirm and cancel modifications buttons

Switch-on time (hh:mm)

Operating duration (hh:mm)

Enabling the configured time

Buttons for moving between configuration pages

Day configuration page 2/2:

It allows you to configure the second daily switch-on time and contains the same configurations as page 1/2.

CHAPTER 7: ACCESS LEVELS

ACCESS LEVELS TO PARAMETERS (USER / INSTALLER)

7.1

The controller has two access levels to the parameters and to the functions: “**User**” and “**Installer**”. The default setting is User that has a parameter menu that can be customised by the installer. Installer access is by logging in from the « Parameters > Password > installer login » menu and inserting the assigned password.

PASSWORDS SET BY DEFAULT:

Installer Password : 0100

Screen for entering access password



The user logged in as installer is indicated on the Status bar with an open lock. Logout is performed automatically after one minute of inactivity or manually from the « Parameters > Password > Installer Logout » menu



Open lock icon: User logged in as installer.

Lock screen and User / Installer login

7.2

If the « Lock screen with password » function is activated, access as an installer or as a user is based on the entered password while the screen unlocks.

PASSWORDS SET BY DEFAULT:

User Password : 0200

Installer Password : 0100

Locked screen display positioned in Button bar.



By pressing the Unlock button, you reach the Password entry display to unlock the screen.



CHAPTER 8: PARAMETERS

8.1 Access to Parameters menu

Press the "Parameters" button located in the Button Bar to access the control parameter setting menu.



PARAMETERS:
Enters the parameter setting menu

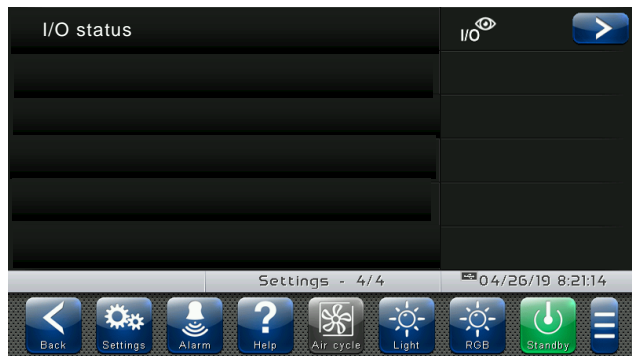
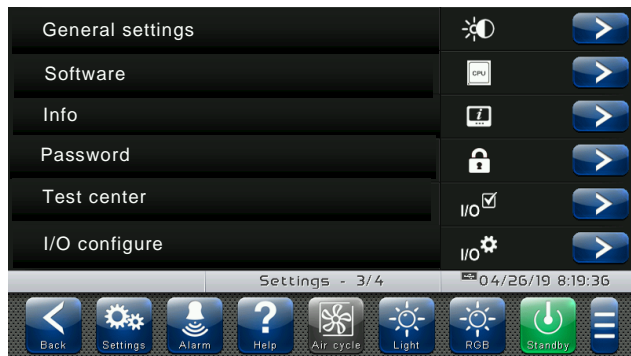
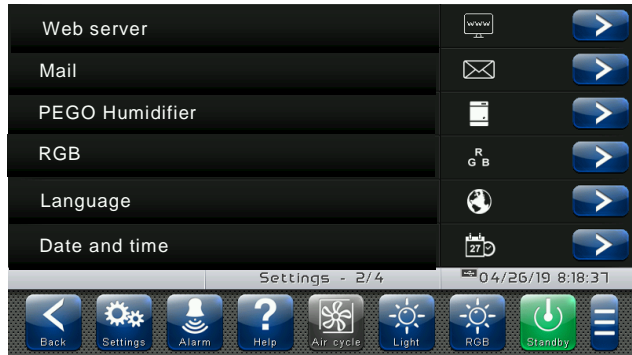
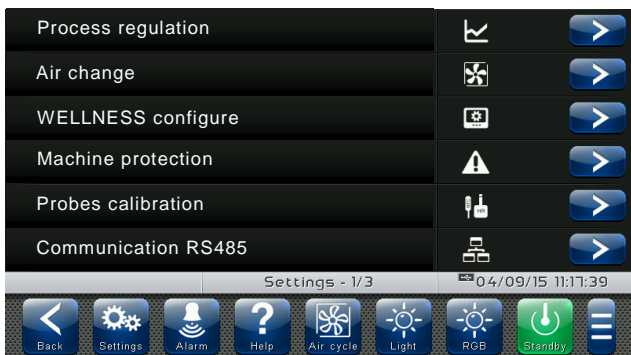

Each item of the parameters menu gathers a list of variables specific for the function described in the menu and in some cases a further submenu. The items present in the main branch are all displayed if you are logged in as "Installer", while the items displayed under "User" depends on the configuration set in "parameters > configure user level menu" visible only if logged in as Installer.

Press any voice inside the main configuration pages to enter its submenu. Each sub-menu contains the name of the variables that can be set, a brief description in the selected language and the currently set value.





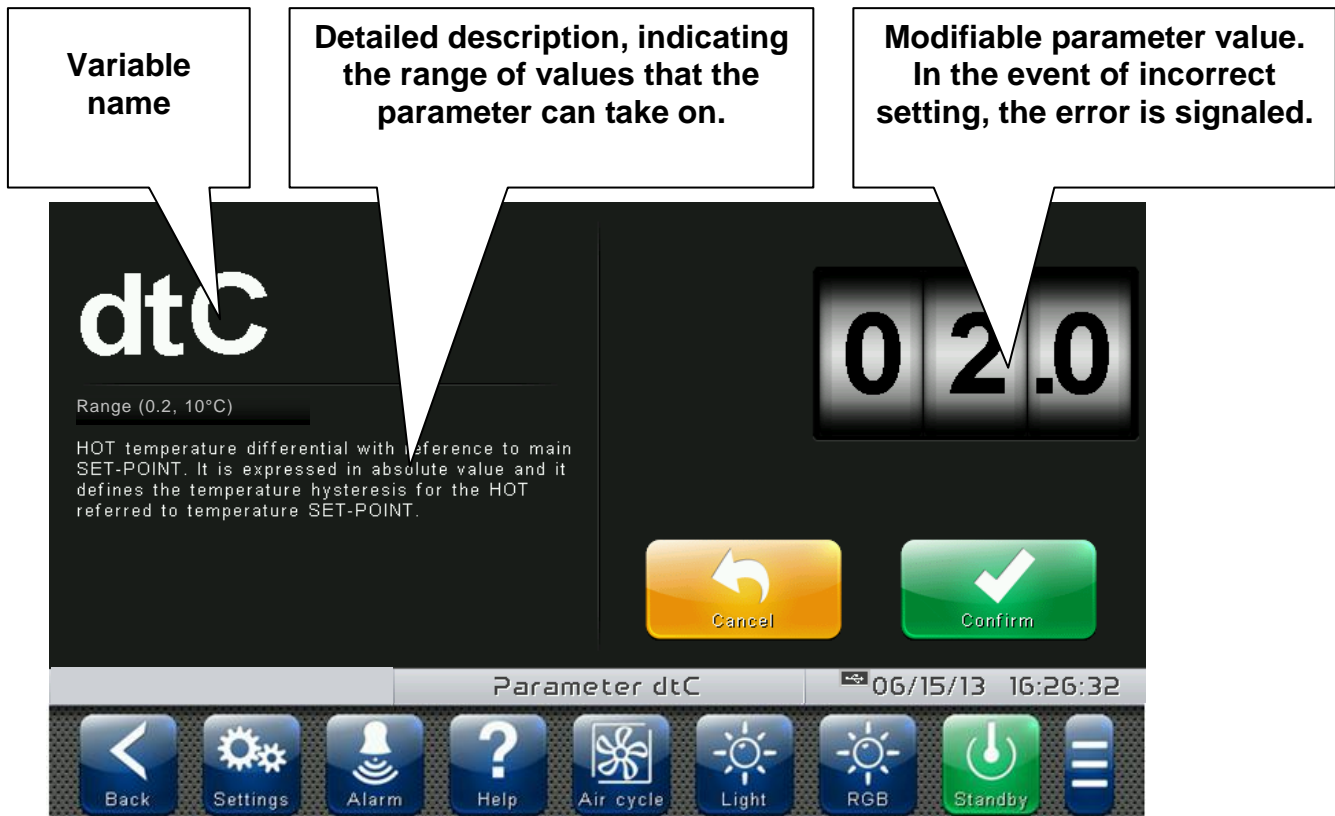











Press the name of the variable to be set to access the relative modification page.







8.3

LIST OF PARAMETER MENU ITEMS

Listed below is the complete list of items displayed in the “Parameters” menu.

Name	Symbol	General description	Chapter
Process regulation		General process parameters (differential and operating time settings)	8.3.1
Air change		Air change time setting	8.3.2
Configure WELLNESS		WELLNESS mode setting	8.3.3
Machine protection		System protection parameters: limits for set-points, operating limit time	8.3.4
Probe calibration		Correction of temperature/humidity probes values.	8.3.5
RS485 communication		Configuration of RS485 serial communication	8.3.6
Web server		Web server configuration	8.3.7
Mail		E-mail configuration	8.3.8
PEGO humidifier		Enabling communication with a PEGO humidifier	8.3.9
RGB		Configuration of RGB light colors	8.3.10
Language		Control unit language setting	8.3.11
Date and time		Date and time settings (This page cannot be accessed while the adjustment is in progress)	8.3.12
General settings		Contrast, brightness and sound alarms setting	8.3.13
Software		Management of control software reset and update, device parameters export/import from USB/SD	8.3.14

Info		VISION TOUCH WELLNESS device information (software version, memory occupied)	8.3.15
Password		Management of protection level: user/installer access, menu configuration	8.3.16
Test center		Digital/analogue inputs/outputs test, touchscreen interface operation test	8.3.17
Configura I/O		Configuration of functions associated to digital/analogue inputs/outputs	8.3.18
Stato I/O		Verify the status of the digital and analogue inputs/outputs	8.3.19

8.3.1

Process adjustment

“Process adjustment” allows setting the differentials and the temperature and humidity neutral area of the WELLNESS.

The “*Process adjustment*” menu can be accessed from the main Configuration page (“Parameters” Button). The display of this item can be set in the “Password” sub-menu => “Configure user level menu” and by selecting the “Process adjustment” item (installer login required).

Process regulation



VARIABLES	MEANING	VALUES	DEFAULT
dtC	HOT temperature differential with reference to main SET-POINT. It is expressed in absolute value and it defines the temperature hysteresis for HOT referred to the temperature SET-POINT.	0,2 ÷ 10,0 °C	2,0 °C
dUU	HUMIDIFICATION differential with reference to humidity SET-POINT. It is expressed in absolute value and it defines the humidification hysteresis referred to the humidity SET-POINT.	1 ÷ 10 rH%	5 rH%
tf	Operating time following a manual or scheduled switch-on (no programmable thermostat)	00:01 ÷ tFm hours	1:00 hours

The air changes can be enabled with parameter EnA. When the operating time elapses air change cycles can only be performed that only activate the ventilation or that activate the ventilation and heating (controlled via the SrA parameter). The duration of the air change is defined by parameter drA.

If the adjustment is off, an air change can be forced by pressing the "Ric. aria" (air change) key.

The "Air change" menu can be accessed from the main Configuration page ("Parameters" Button). The display of this item can be set in the "Password" sub-menu => "Configure user level menu" and by selecting the "Air change" item (installer login required).

Air change



VARIABLES	MEANING	VALUES	DEFAULT
drA	Air change period.	0 ÷ 120 min	45
SrA	Air change temperature setpoint	30,0 ÷ 99,0 °C	40,0 °C

"Configure WELLNESS" allows to select which functions of the WELLNESS control unit are enabled; in particular, it allows the operating mode to be configured and the management of the air and programmable thermostat to be enabled/disabled.

The "Configure WELLNESS" menu can be accessed from the main Configuration page ("Parameters" Button). The display of this item can be set in the "Password" sub-menu => "Configure user level menu" and by selecting the "Configure WELLNESS" item (installer login required).

Configure WELLNESS



VARIABLES	MEANING	VALUES	DEFAULT
EnA	Air change enabling	0 = disabled 1 = enabled (ventilation only) 2 = enabled (ventilation + hot)	0
EnC	Enabling the programmable thermostat	0 = disabled 1 = enabled	0
mOd	Functioning mode	0 = sauna 1 = wet sauna 2 = turkish bath	0

8.3.4

Machine protection

“Machine protection” contains the safety parameters to manage the system. The “*Machine protection*” menu can be accessed from the main Configuration page (“Parameters” Button). The display of this item can be set in the “Password” sub-menu => “Configure user level menu” and by selecting the “*Machine protection*” item (installer login required).

Machine protection



VARIABLES	MEANING	VALUES	DEFAULT
<i>tFm</i>	Maximum settable operating time	00:01 ÷ 12:00 (hh:mm)	06:00
<i>HSt</i>	Maximum value that can be attributed to the temperature setpoint	+20,0 ÷ +99,0 °C	+99,0°C

8.3.5

Probe calibration

The “*Probes calibration*” menu allows to correct the value measured by the temperature and humidity probes. The menu can be accessed from the main Configuration page (“Parameters” Button). The display of this item can be set in the “Password” sub-menu => “Configure user level menu” and by selecting the “*Probes calibration*” item (installer login required).

Probe calibration



VARIABLES	MEANING	VALUES	DEFAULT
<i>Cat</i>	Ambient probe value correction	-10,0 ÷ +10,0 °C	0,0
<i>CaU</i>	Humidity probe value correction	-20 ÷ +20 Rh%	0

The “RS485 communication” menu allows to set the serial communication configuration. The menu can be accessed from the main Configuration page (“Parameters” Button). The display of this item can be set in the “Password” sub-menu => “Configure user level menu” and by selecting the “RS485 communication” item (installer login required).

In the event of **Ser=0** (Telenet), the Vision Touch responds as a TWMT instrument (**room temperature probe measurement**) to address Ad and as a TWMUR instrument (**room humidity probe measurement**) to the same address.

RS485 communication



VARIABLES	MEANING	VALUES	DEFAULT
Ad	Network address for connection to TeleNET or Modbus supervision system.	0 ÷ 31 (Ser=0) 1 ÷ 247 (Ser=1)	0
Ser	RS-485 communication protocol 0 = TeleNET protocol 1 = Modbus-RTU protocol	0 ÷ 1	0
Bdr	Modbus baudrate 0 = 300 baud 1 = 600 baud 2 = 1200 baud 3 = 2400 baud 4 = 4800 baud 5 = 9600 baud 6 = 14400 baud 7 = 19200 baud 8 = 38400 baud	0 ÷ 10	5
Prt	Modbus parity control configuration. 0 = none parity 1 = even parity 2 = odd parity	0 ÷ 2	0
tRM	Terminating resistor	0 = disabled 1 = enabled	0

8.3.7 *Web server*

The "Web server" menu allows setting the Web server configuration. This menu is accessible from the Main Configuration page ("Parameters" Button). The visibility of this item can be set in the submenu "Password" => "Configure user level menu" and by selecting the "Web server" item (installer login required).

The screenshot shows a dark-themed menu titled "Web server" with a "www" icon and a right arrow. The menu items are:

- Settings
- User name
- Command enable
- Info

Callout boxes provide the following descriptions:

- Basic configuration of Web server (IP, Netmask, Gateway, DHCP)** points to the "Settings" option.
- Setting up your username for login from the web** points to the "User name" option.
- Enable the change of parameters / controls from web** points to the "Command enable" option.
- "Info" checks the current Web server setting (IP, MAC, etc.)** points to the "Info" option.

The bottom of the screen shows a status bar with "Web server -" and the date/time "09/29/17 8:31:53".

- Settings page

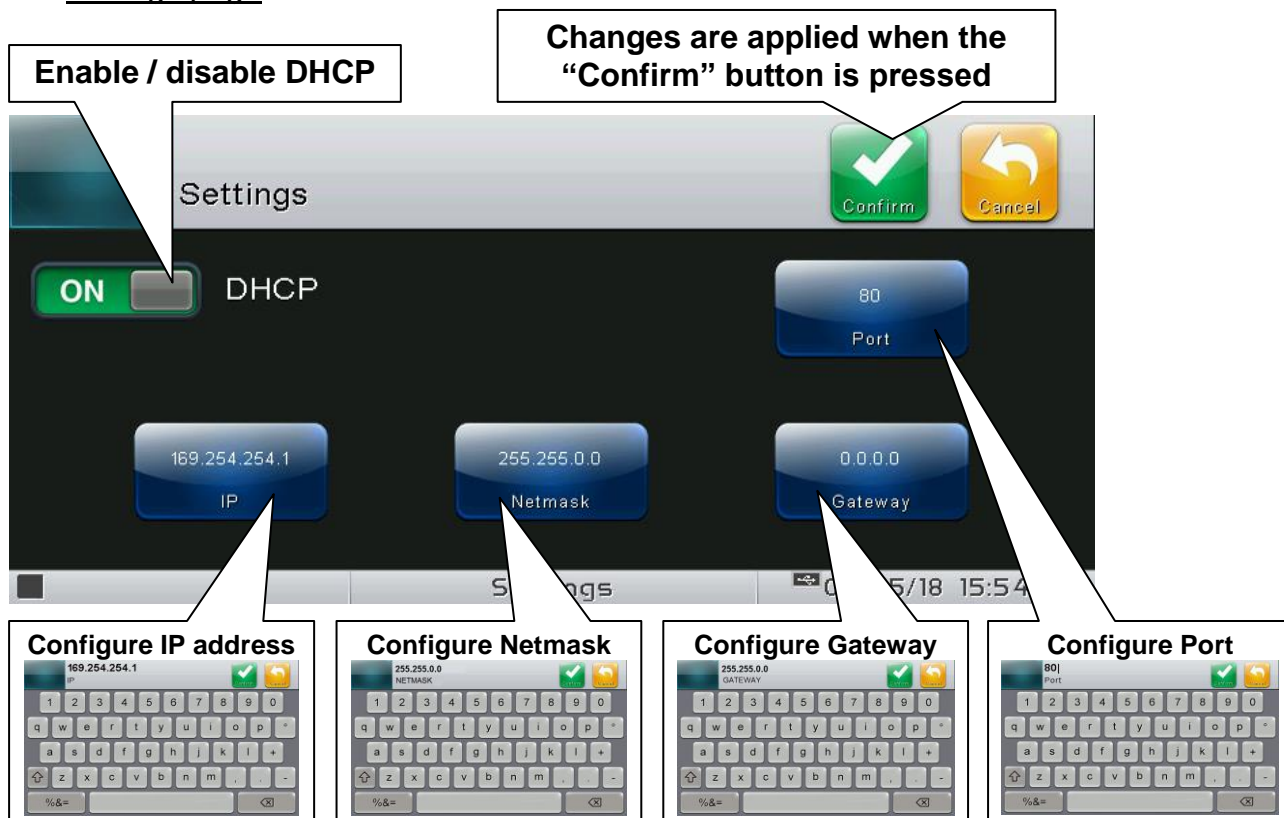

- DHCP: enable / disable configuration request to the DHCP server. If enabled, the IP address associated with Vision Touch is assigned by the DHCP server (if it is present on the local network). If no assignment is made, the touch maintains the default configuration:

IP: 169.254.254.1
Netmask: 255.255.0.0

Gateway: 0.0.0.0
Port: 80

To check the configuration assigned by DHCP, see the "Info" page in the "Web server" menu.

- **Configure IP address / Netmask / Gateway:** allow the setting of IP address / Netmask / Gateway if DHCP is not used (for example in static IP setting).

- **Configure Port:** allows you to change the access port of the Web Server. In case of connection of multiple Vision Touch on the same local network, set the NAT of the router by associating local IP/port with public IP/port.

Warning: changing the port requires restarting the Vision Touch.

Example:

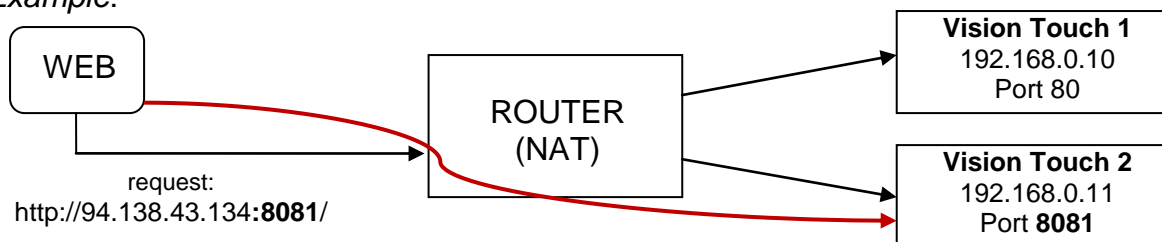

– User name page

The page “User name” allows configuring the Username to be used during login on the Vision touch Web page (the password coincides with the Vision Touch Installer password).

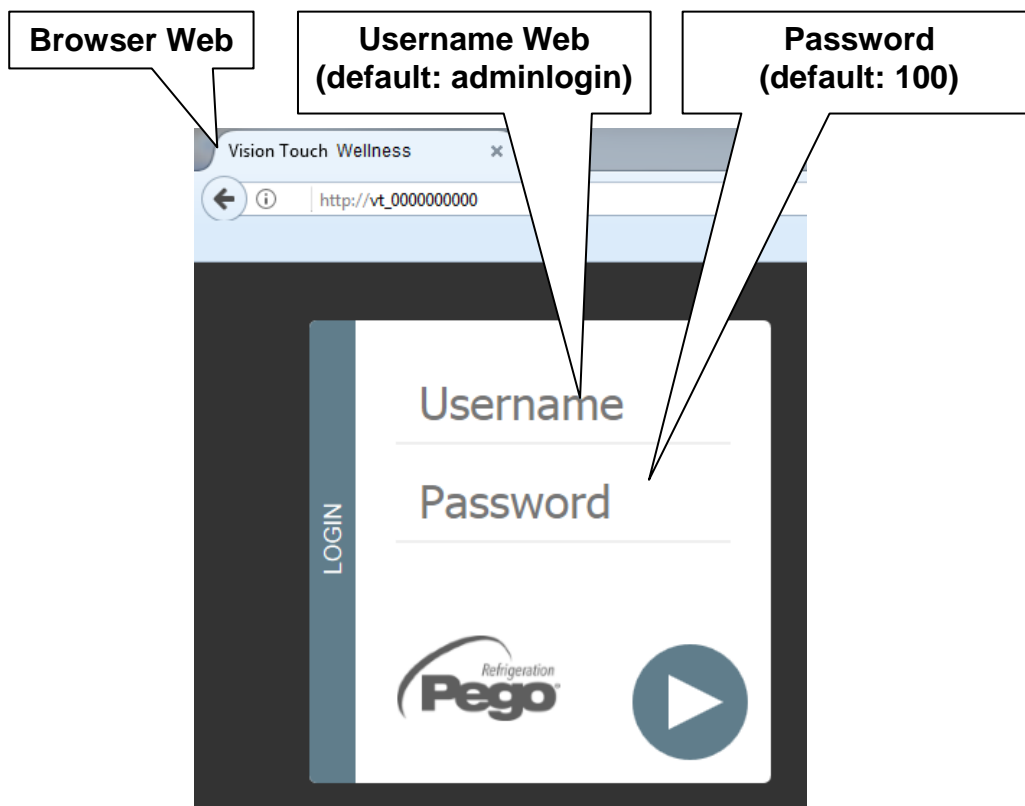

- Command enable page

The Wce parameter allows enabling or disabling commands and edits parameters from the Web page, regardless of the type of user (user or admin) that accesses the Web page.

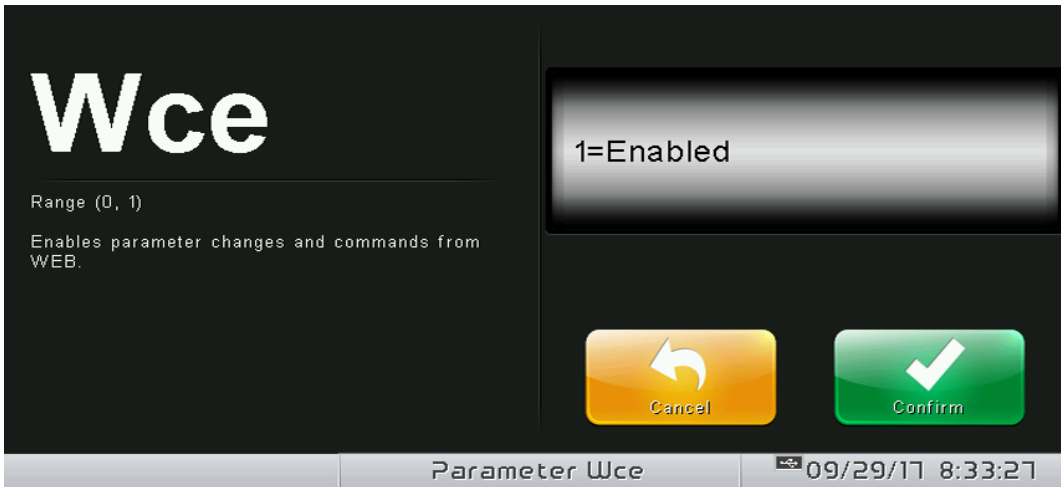

- Info page

The "Info Page" allows checking the current Web configuration of the Vision Touch Wellness.



DHCP: DHCP assignment status

Host: name used in the web browser address bar (linked to the serial number)

IP / Netmask / Gateway: current configuration (set either locally or by DHCP)

MAC: unique physical address associated with Vision Touch

User name: Web user name

8.3.8

Mail

The “Mail” menu allows setting the alarm mail configuration. The menu can be accessed from the main Configuration page (“Parameters” Button). The display of this item can be set in the “Password” sub-menu => “Configure user level menu” and by selecting the “Mail” item (installer login required).



VARIABLES	MEANING	VALUES	DEFAULT
Enable	Enable sending of mails in case of alarm. If configured as “Test Mail” it sends a test mail to all recipients.	0=Disabled 1=Enabled 2=Test mail	0
Sender	Sender e-mail configuration (e.g. xxxxx@yyy.zz)	Text	
Password	Sender e-mail password configuration	Text	
SSL	Enable secure communication with the mail server	0=Disabilitato 1 = Abilitato	1
Port	Mail port number (e.g. port 465 for SSL connection, port 25 for non-SSL connection.)	0 ... 999	465
Server mail	Outgoing mail server (e.g. smtp.xxx.zz)	Text	
Subject mail	Subject of mails (e.g. Cold room 1)	Text	
Receiver 1 Receiver 2 Receiver 3	E-mail receivers (xxxxx@yyy.zz). The alarm e-mail will be sent to all receivers.	Text	

The Vision Touch sends an e-mail when an alarm occurs and when the alarm returns. The email contains the following information:

- Alarm code and description
- date and time when the alarm started
- duration of the alarm (in case of alarm end email).



CONNECTION	
PIN TERMINALS (100NMASTER)	PIN TERMINALS (EASYSTEAM)
37	32
38	31

Enables communication with the PEGO humidifier.
Verify that jumper J2 inside the 100N MASTER is open and that the humidifier has address Ad = 1.

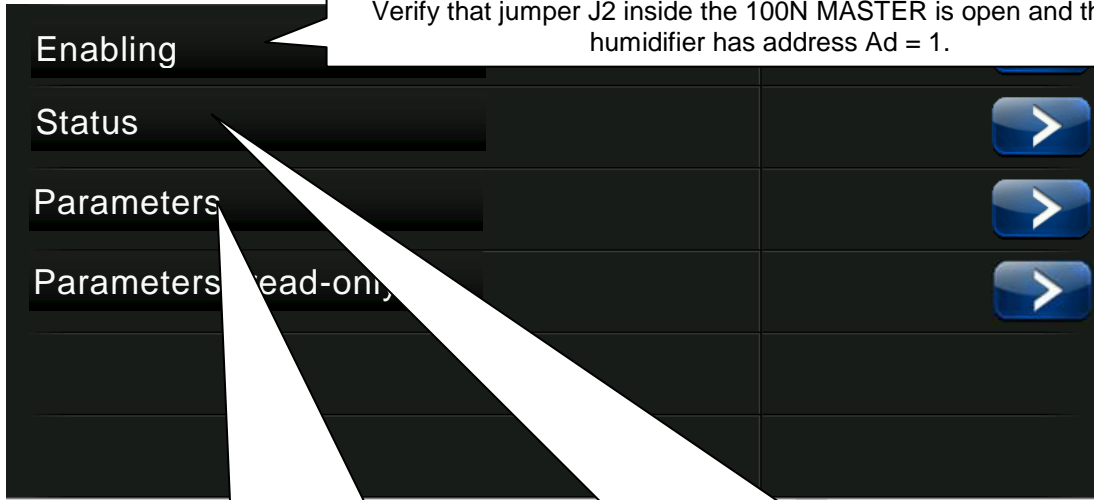

Access to the read/edit functions of the main parameters.

Summary page of the status of inputs/outputs of the humidifier.
The humidifier can be set to standby or the water can be forced to drain on this page.

ENABLING

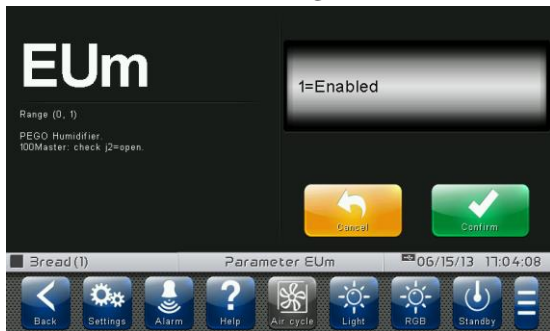

STATUS



PARAMETERS

Pr	Steam output	97 %	>
S0	Decon. disch. time	2.0 sec	>
S2	Decon. disc. interval	6 min	>
S4	Disch. for inactivity	1 hours	>
S8	Current diff. for charge	0.1	>
S9	Functioning setting set	8	>

8.3.10

RGB

The “RGB” menu allows to change the RGB light colour. The menu can be accessed from the main Configuration page (“Parameters” Button). The display of this item can be set in the “Password” sub-menu => “Configure user level menu” and by selecting the “RGB” item (installer login required).

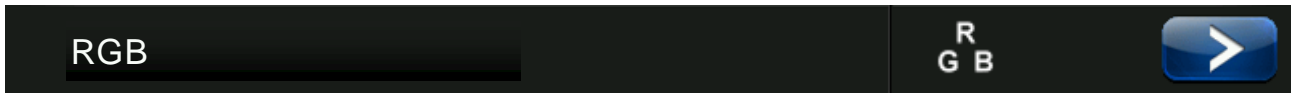

VARIABLES	MEANING	VALUES	DEFAULT
Ldt	Speed of the colour sequence during the automatic cycle.	1 ÷ 120 sec	1 sec
Lcy	Type of colour cycle. 1 = 120 colours 2 = 4 colours(red, yellow, green, blue) 3 = cold cycle 4 = hot cycle	1 ÷ 4	1

8.3.11

Language

The “Language” menu allows to change the control unit language. The menu can be accessed from the main Configuration page (“Parameters” Button). The display of this item can be set in the “Password” sub-menu => “Configure user level menu” and by selecting the “Language” item (installer login required).



The “Date and time” menu allows to change the clock settings. **This page cannot be accessed while the adjustment is in progress.** The “Date and time” menu can be accessed from the main Configuration page (“Parameters” Button). The display of this item can be set in the “Password” sub-menu => “Configure user level menu” and by selecting the “Date and time” item (installer login required).

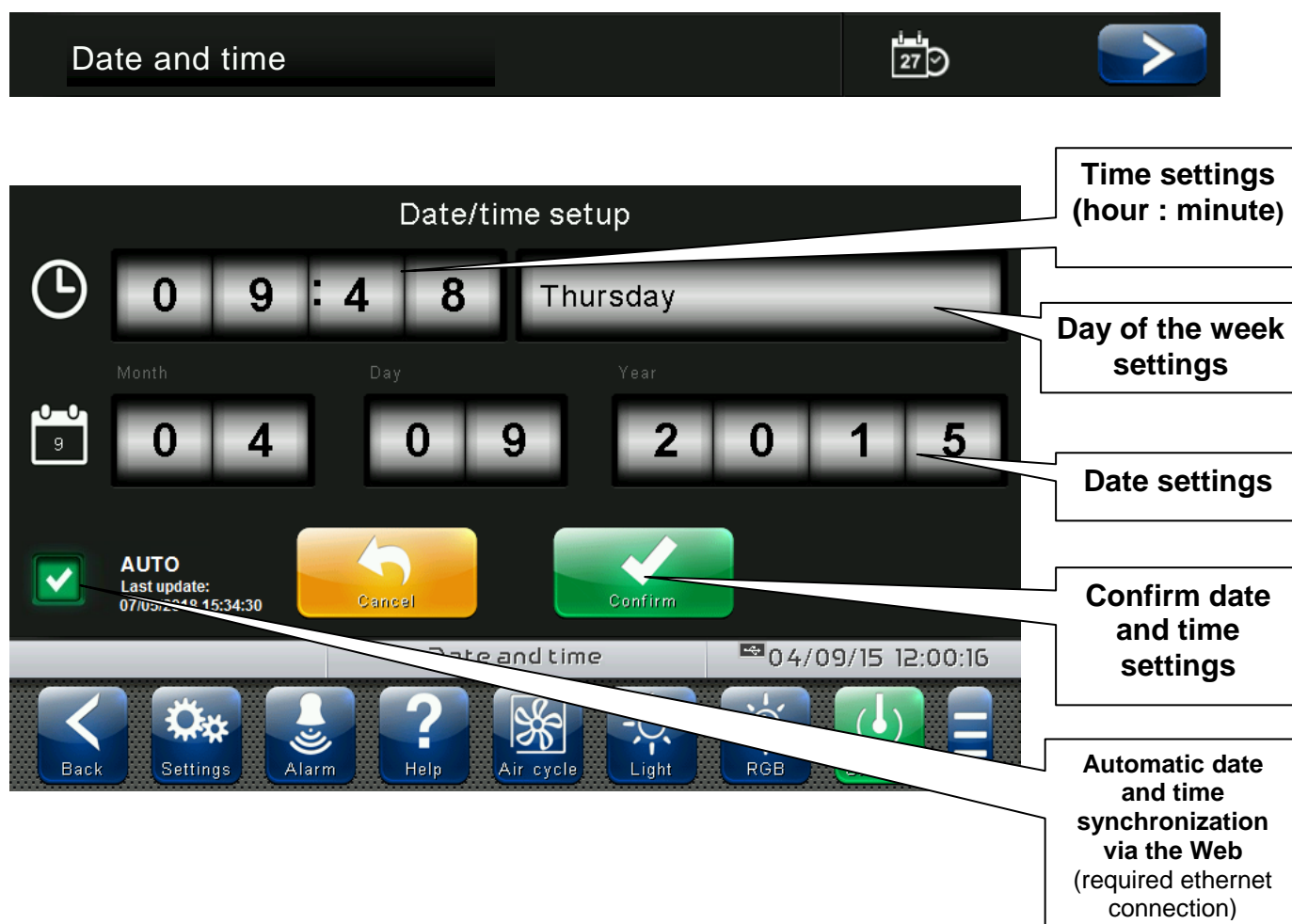

If automatic synchronization via the Web is active, the control connects to an external service that automatically determines the correct time zone and sets the date and time considering any summer / winter time. The status of the last synchronization attempt (referred to as "Last update") can be:

- **None:** no attempt to synchronize (for example at first power up);
- **Error:** the last synchronization attempt was not successful and therefore the control keeps the date and time settings previously set;
- **dd/mm/yyyy hh:mm:ss:** date and time of the last synchronization correctly performed.

8.3.13

General settings

The “General settings” menu allows to change the screen contrast, the brightness when the screen is locked, the activation of the sound alarms and the activation of the screensaver. “General settings” can be accessed from the main Configuration page (“Parameters” Button). The display of this item can be set in the “Password” sub-menu => “Configure user level menu” and by selecting the “General settings” item (installer login required).

We recommend setting the brightness to the minimum in order to maximize the display's lifetime.

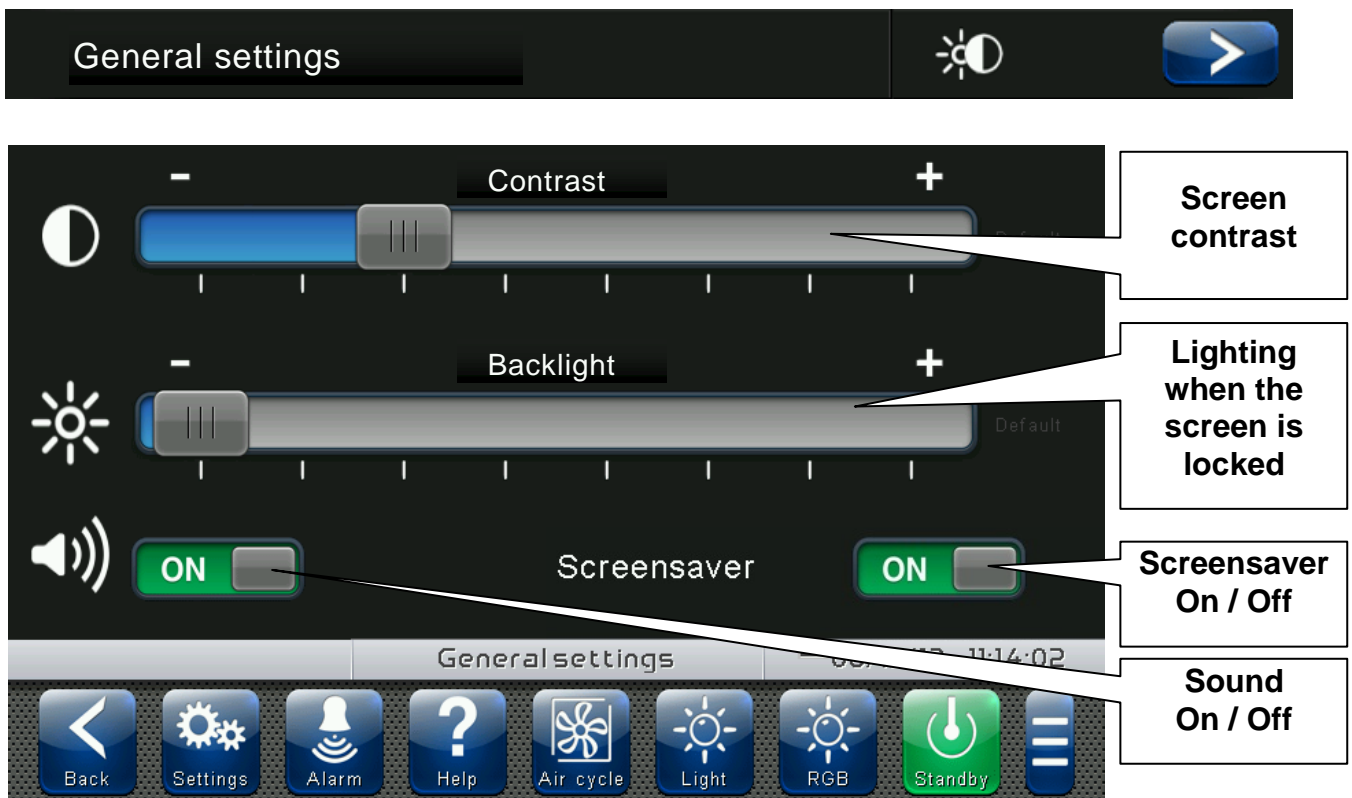

The “*Software*” menu allows to perform maintenance on the device software. The menu can be accessed from the main Configuration page (“Parameters” Button). The display of this item can be set in the “Password” sub-menu => “Configure user level menu” and by selecting the “*Software*” item (installer login required).

The screenshot shows the 'Software' menu with the following options: Software update, Reload factory values, Clone machine configuration, and Repair EEPROM. A callout box points to 'Reload factory values' with the text: **Restore all default settings.** The execution of the program in progress is interrupted but the stored programs are not deleted. Another callout box points to 'Repair EEPROM' with the text: **Repairing errors in the internal memory of the control unit**. A third callout box points to 'Software update' with the text: **Exporting/importing the parameters configuration from USB / SD**. The interface also shows a 'CPU' indicator, a right arrow button, and a bottom dock with icons for Back, Settings, Alarm, Help, Air cycle, Standby, and a menu icon. The status bar at the bottom shows the date 06/15/13 and time 11:17:28.

Software updating procedure:

- Copy the update file "VT_ WEL_#_#_#_#.pego" (the symbols # represent the progress of the version) to an empty USB pen drive. Only the update file must be present in the pen drive.
- Insert the USB pen drive in the USB1 port of the controller (the symbol  of USB inserted and acknowledged appears on the status bar).
- Press the "Update software" button.
- The device proceeds to update autonomously, performing the following steps (the operation requires a few minutes): it exports the programs and configurations (if applicable) > it deletes the internal memory and installs new software > it restores the programs and configurations (if applicable) > it restarts the VISION TOUCH WELLNESS.

ATTENTION: during the entire installation phase **the controller must be kept powered and the USB key must be left inserted.** Failure to comply with this requirement could entail PEGO S.r.l. having to restore the software.

The update finishes as soon as the controller goes back to the "HOME 1" screen; at this point you can remove the USB key and resume normal use.

The new Software version can be checked in the "Parameters" > "Info" menu under "Application Version".

8.3.15

Info

The "Info" menu contains information relating to the software version installed and other information about the device. The menu can be accessed from the main Configuration page ("Parameters" Button).



The “*Password*” menu allows to manage the device protection level, giving the user permission to access only certain functions and parameters. The menu can be accessed from the main Configuration page (“Parameters” Button).



The “*Password*” menu has a different appearance for the user and for the installer: the installer can select which items of the parameters menu are displayed to the user and which actions can be performed by the latter.

- User Password Page

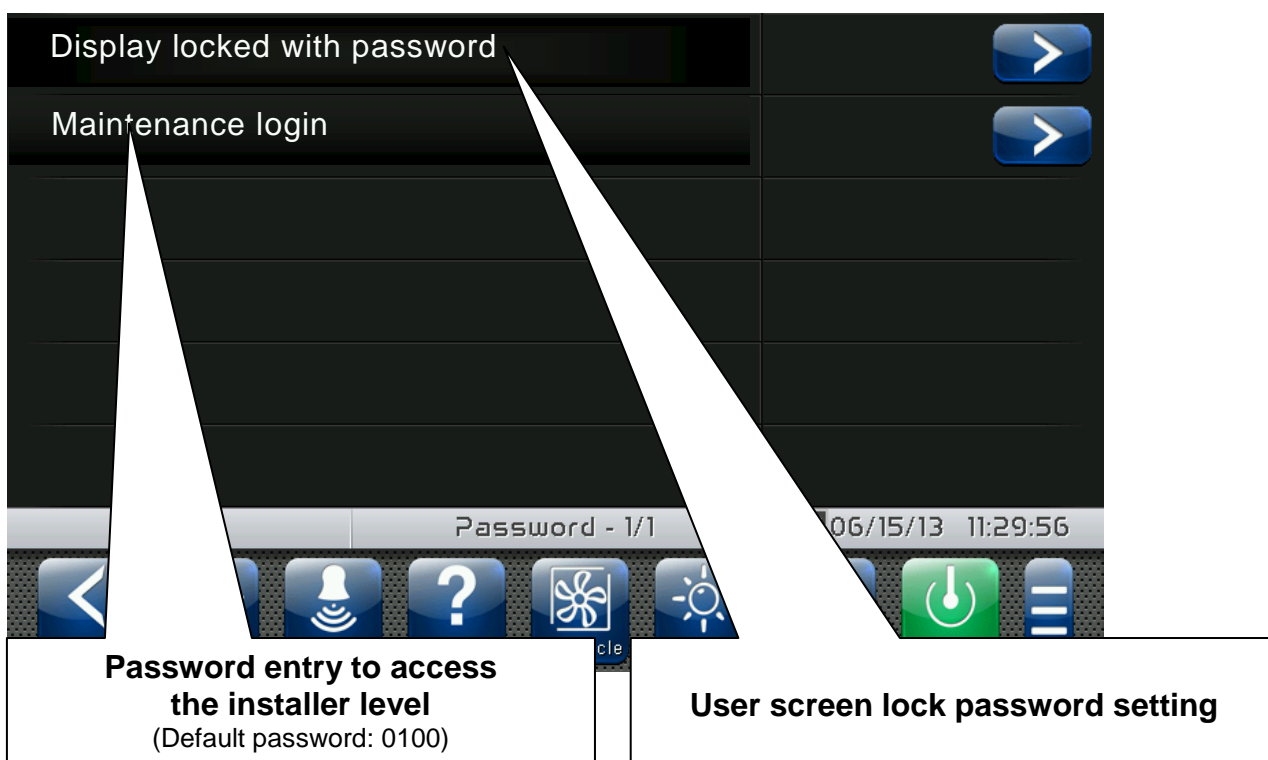

- Installer Password Page

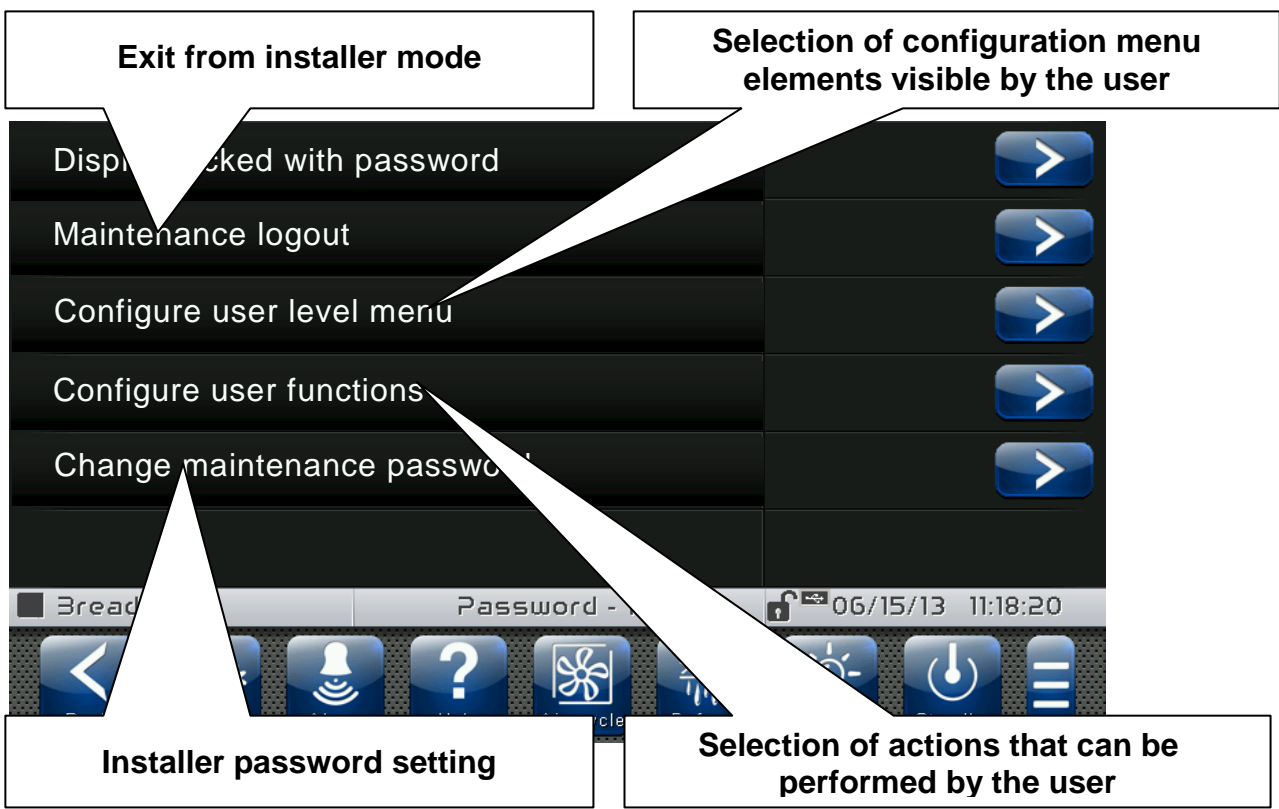

The “Test centre” allows to verify the proper operation of the inputs/outputs of the 100N MASTER3 connected to the VISION TOUCH WELLNESS. One can also verify the operation of the touchscreen sensors.

**The “Test centre” function is reserved to expert users.
Pego S.r.l. disclaims any liability for damage to the system
due to improper use of this function.**

The “Test centre” menu can be accessed from the main Configuration page (“Parameters” Button). The display of this item can be set in the “Password” sub-menu => “Configure user level menu” and by selecting the “Test centre” item (installer login required).

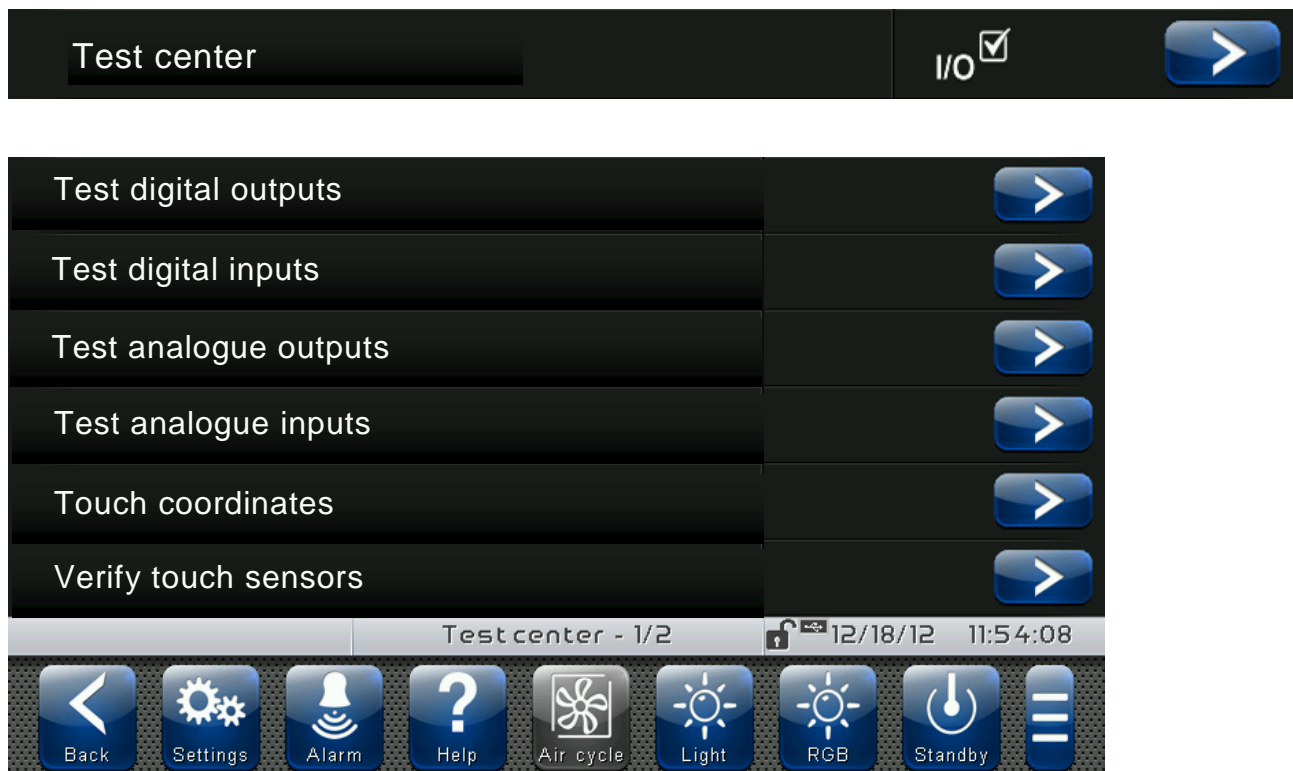

- Digital outputs test

The “Digital outputs test” allows to manually force the digital outputs of the connected 100N MASTER3. Access to this menu put the control unit in “Stand by”: the time progress of an ongoing program is not altered but all output functions are disabled.

The function associated to each digital output can be set in “Parameters” => “Configure I/O” => “Digital outputs”.

Press to enable / disable a digital output

Output function (can be set)

Connection terminals

- Digital inputs test

The “Digital inputs test” allows to verify the correct acquisition of the digital inputs of the connected 100N MASTER3. The function associated to each digital input can be set in “Parameters” => “Configure I/O” => “Digital inputs”.

In presence of an active digital input the indicator light turns green

Input function (can be set)

Connection terminals

- Analogue outputs test

The “Analogue outputs test” allows to manually force the analogue outputs of the connected 100N MASTER3, by setting the values manually between 0 and 10V. Access to this menu put the control unit in “Stand by”: the time progress of an ongoing program is not altered but all output functions are disabled.

The function associated to each digital output can be set in “Parameters” => “Configure I/O” => “Analogue outputs”.

41 Ref. 44 Gnd	AO1	RGB adjustment Red	+ 0V -
42 Ref. 44 Gnd	AO2	RGB adjustment Green	+ 0V -
43 Ref. 44 Gnd	AO3	RGB adjustment Blue	+ 0V -

est analogue output 04/10 15:17:5

Back Settings ? Help Air cycle RGB

Connection terminals

Output description

Increase (+) / Decrease (-) the value of an analogue output

- Analogue inputs test

The “Analogue inputs test” allows to verify the correct acquisition of the analogue inputs (probes) of the connected 100N MASTER3. The function associated to each digital output can be set in “Parameters” => “Configure I/O” => “Analogue inputs”.

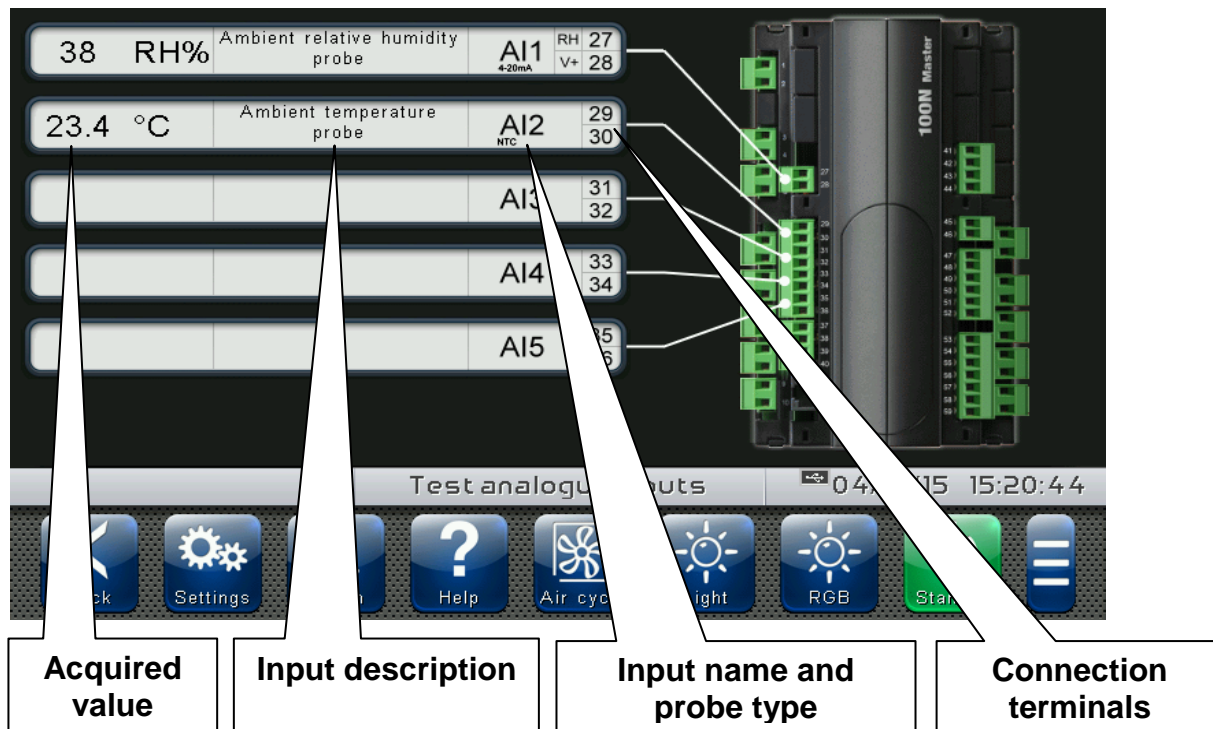

8.3.18

Configure I/O

“Configure I/O” allows to set the function associated to each input/output of the connected 100N MASTER3.

The “Configure I/O” function is reserved to expert users. Pego S.r.l. disclaims any liability for damage to the system due to improper use of this function.

The “Configure I/O” menu can be accessed from the main Configuration page (“Parameters” Button). The display of this item can be set in the “Password” sub-menu => “Configure user level menu” and by selecting the “Configure I/O” item (installer login required).

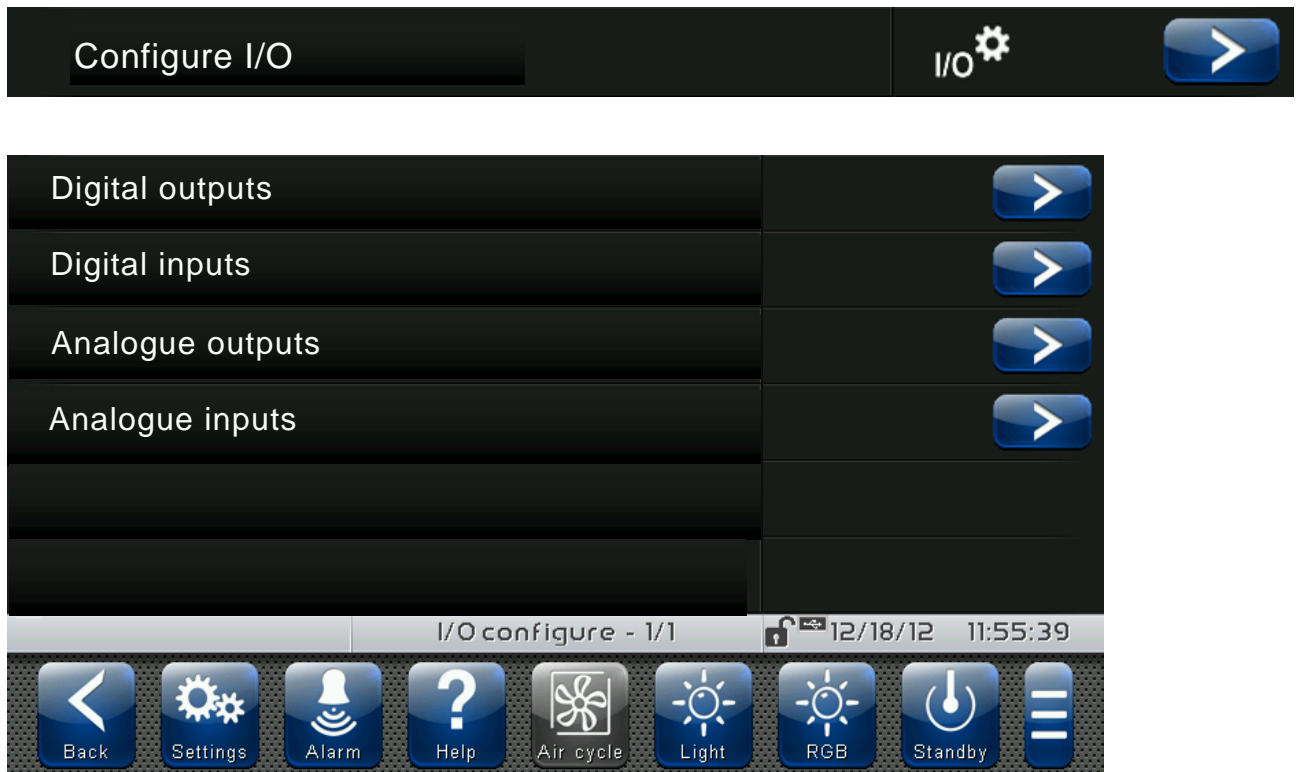

- Digital outputs

“Digital outputs” allows to change the function associated to each digital output of the connected 100N MASTER3. The modification of an output puts the control unit in “Stand by”. In the event a function is not associated to at least one output, the eventual call from the control unit will not activate any digital output (only the status icon will be activated to indicate a call).

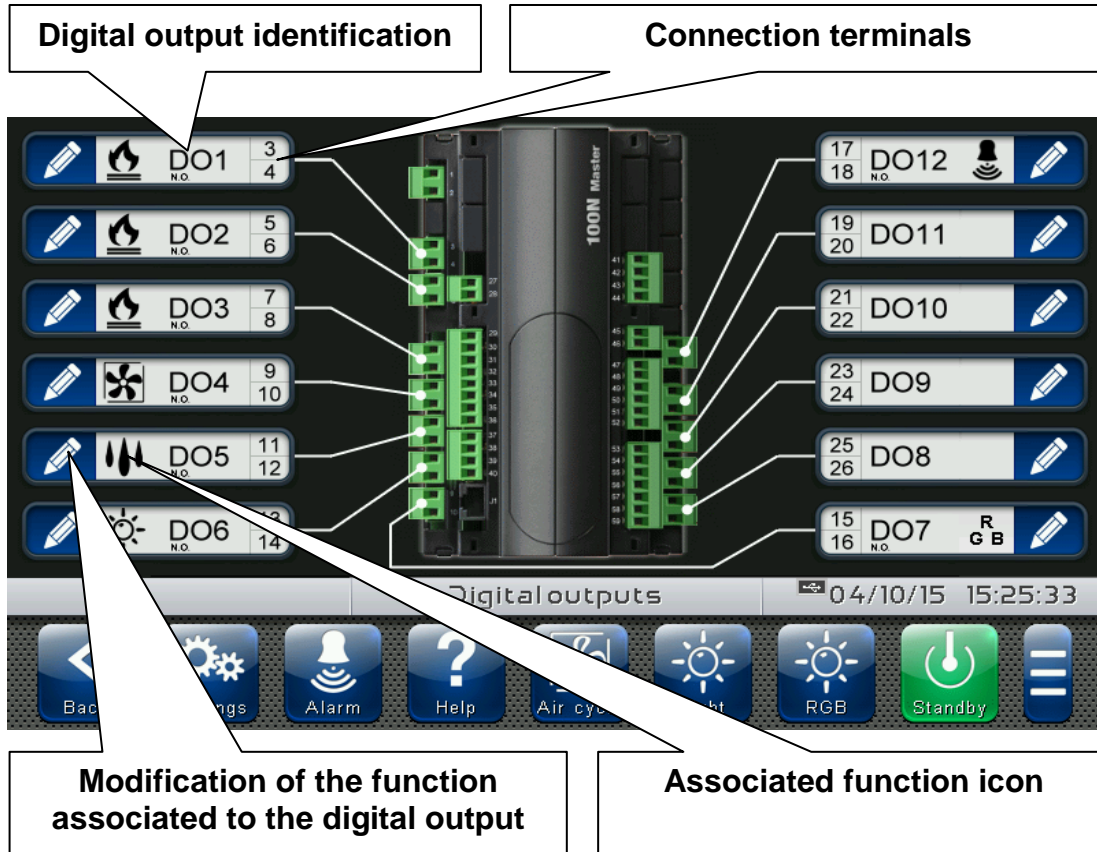

- Digital inputs

“Digital inputs” allows to modify the function associated to each digital input of the connected 100N MASTER3. The modification of an input puts the control unit in “Stand by”.

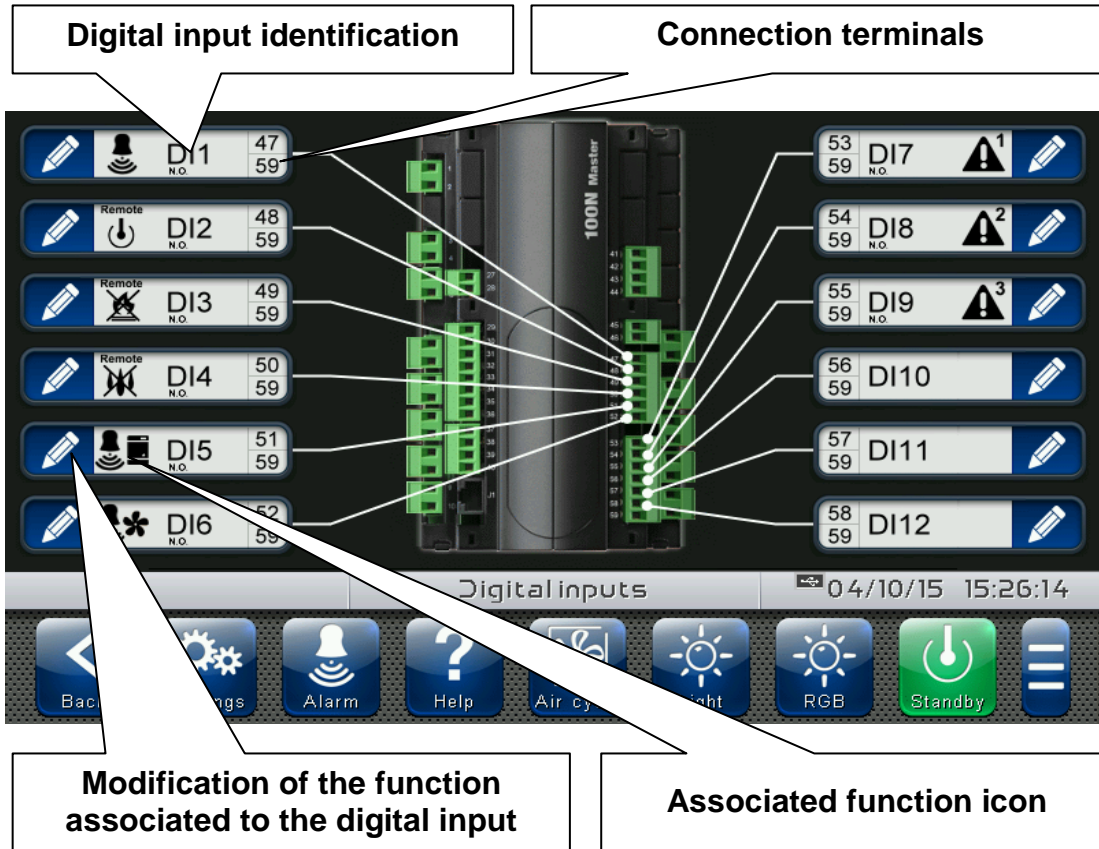

- Analogue outputs

“Analogue outputs” allows to change the function associated to each analogue output of the connected 100N MASTER3. The modification of an output puts the control unit in “Stand by”. In the event a function is not associated to at least one output, the eventual call from the control unit will not activate any analogue output (only the status icon will be activated to indicate a call).

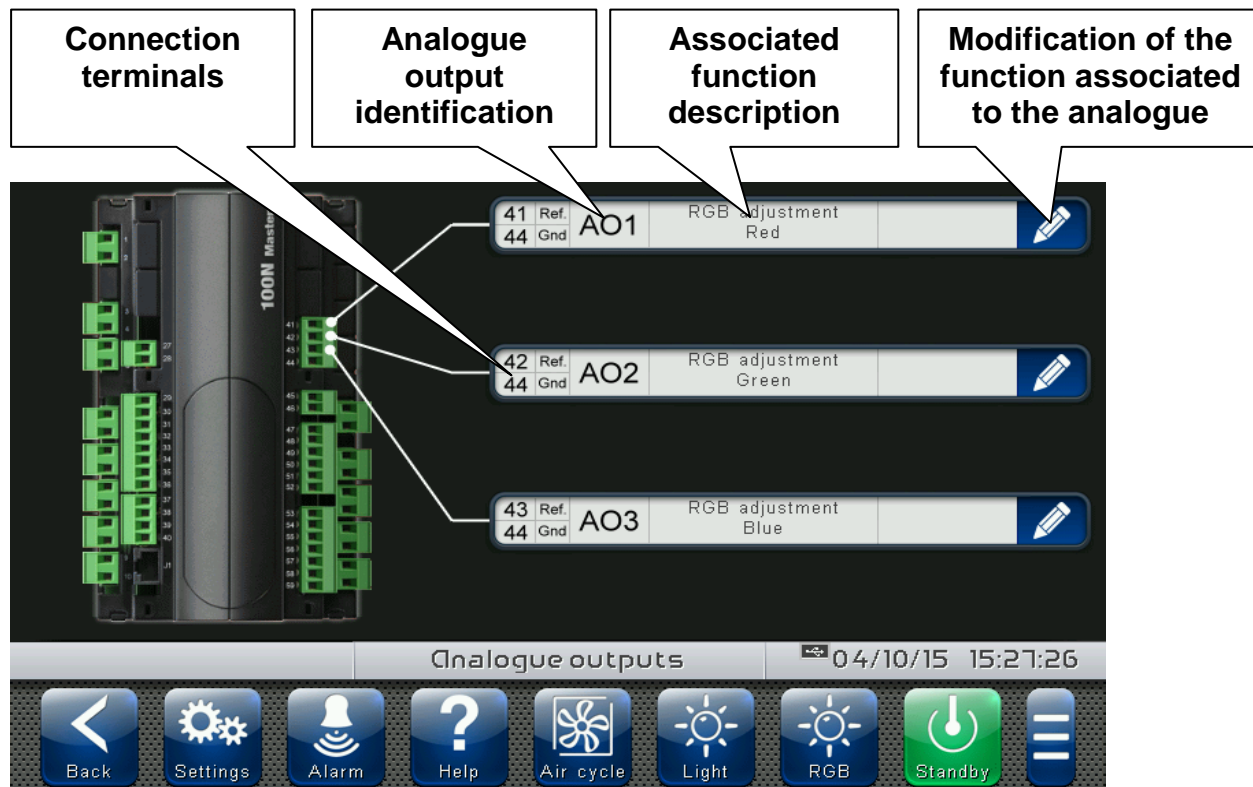

- Analogue inputs

“Analogue inputs” allows to modify the function associated to each analogue input of the connected 100N MASTER3. The modification of an input puts the control unit in “Stand by”. In the event of an incorrect association between a probe and a function, the alarm is signalled (Ec1 ÷ Ec3).

Modification of the function associated to the analogue input	Associated function description	Analogue input identification	Connection terminals
	Ambient relative humidity probe	AI1 4-20mA	27 V+ 28
	Ambient temperature probe	AI2 NTC	29 30
		AI3	31 32
		AI4	33 34
		AI5	35 36

Analogue inputs 04/10/15 15:28:52

Back Settings Alarm Help Air cycle Light RGB Standby

“I/O Status” allows the status of each input/output of the connected 100N MASTER3 to be displayed.

The “I/O Status” menu can be accessed from the main Configuration page (“Parameters” Button). The display of this item can be set in the “Password” sub-menu => “Configure user level menu” and by selecting the “I/O Status” item (installer login required).

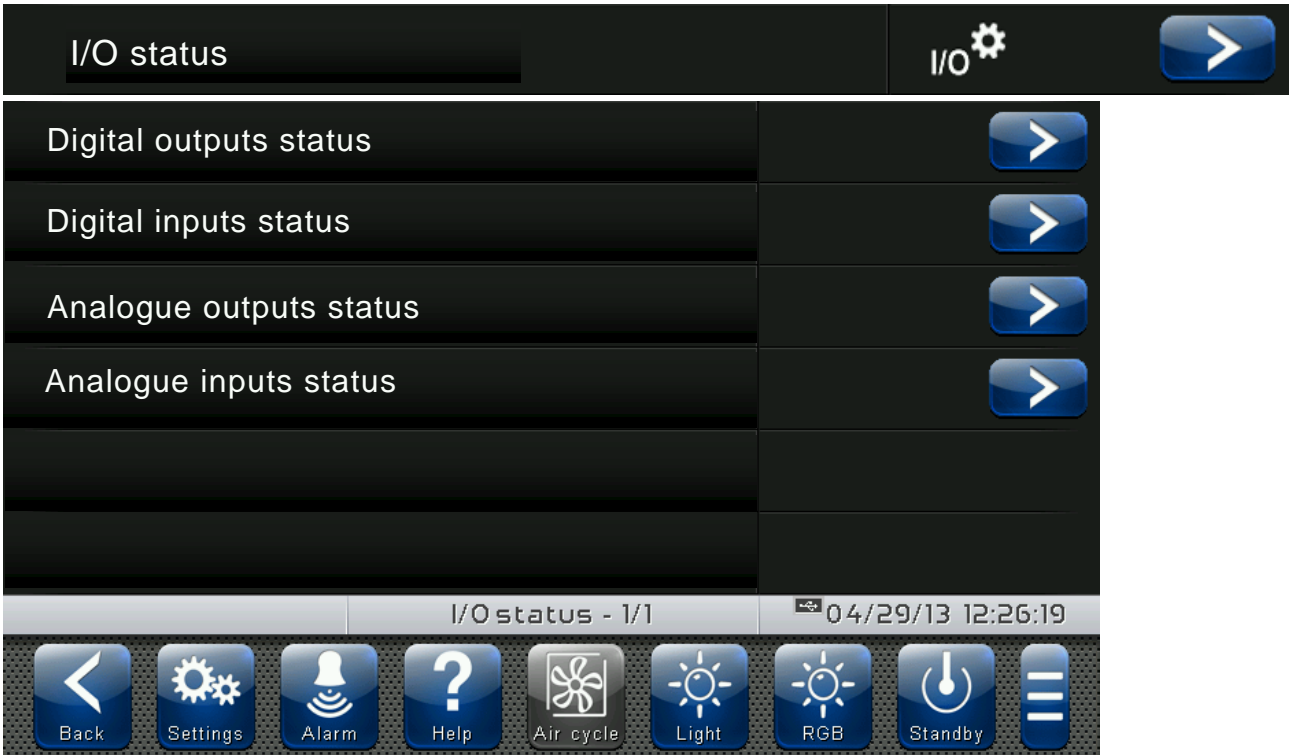

DIGITAL OUTPUTS

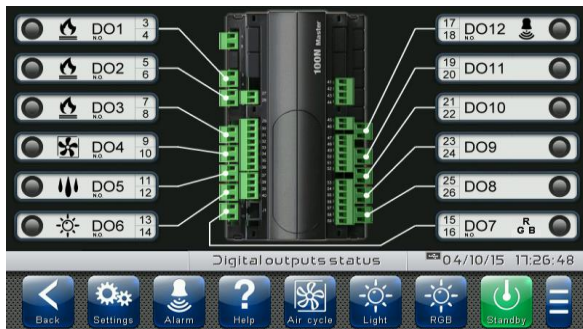

DIGITAL INPUTS

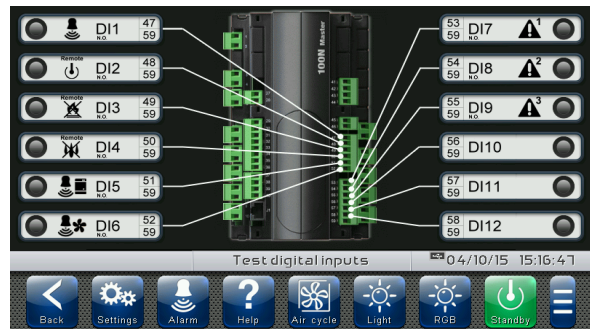

ANALOGUE OUTPUTS

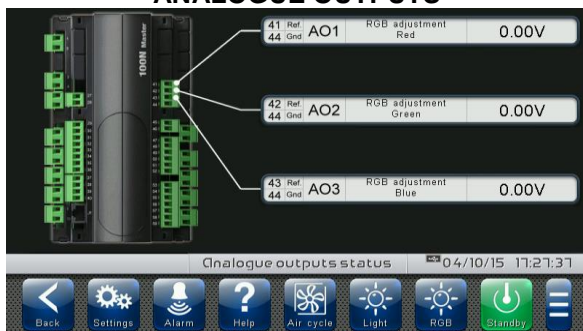

ANALOGUE INPUTS

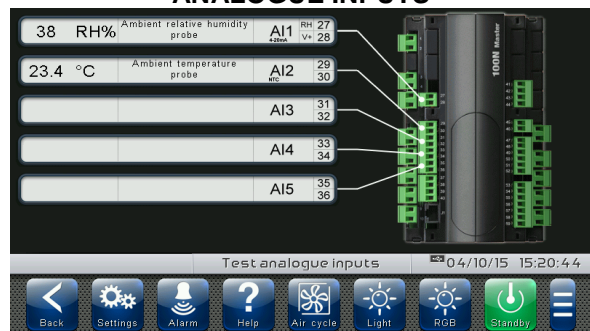

CHAPTER 9: DIAGNOSTICS

9.1

DIAGNOSTICS

If any faults occur, the VISION TOUCH WELLNESS controller informs the operator, by means of alarm codes visualised on the display (via pop-up or on the 'Alarms' page) and an acoustic signal emitted by a buzzer inside the operating Console (if enabled). One of the following messages appears on the screen when an alarm condition occurs:

ALARM CODE	POSSIBLE CAUSE	SOLUTION
E0	<i>EEPROM Vision Touch alarm</i>	<ul style="list-style-type: none"> • Switch the appliance off and back on. • Select 'Repair EEPROM' in the 'Software' menu. • If the problem persists, contact the technical assistance service.
E0m	<i>EEPROM 100N MASTER alarm</i>	<ul style="list-style-type: none"> • Switch the appliance off and back on. • If the problem persists, contact the technical assistance service.
E1	<i>Probe connected to channel 1 functional fault</i>	<ul style="list-style-type: none"> • Check the probe status. • Verify that its configuration is correct in the "Configure I/O>Analogue Inputs" menu.
E2	<i>Probe connected to channel 2 functional fault</i>	<ul style="list-style-type: none"> • Check the probe status. • Verify that its configuration is correct in the "Configure I/O>Analogue Inputs" menu.
E3	<i>Probe connected to channel 3 functional fault</i>	<ul style="list-style-type: none"> • Check the probe status. • Verify that its configuration is correct in the "Configure I/O>Analogue Inputs" menu.
E4	<i>Probe connected to channel 4 functional fault</i>	<ul style="list-style-type: none"> • Check the probe status. • Verify that its configuration is correct in the "Configure I/O>Analogue Inputs" menu.
E5	<i>Probe connected to channel 5 functional fault</i>	<ul style="list-style-type: none"> • Check the probe status. • Verify that its configuration is correct in the "Configure I/O>Analogue Inputs" menu.
Eg	<i>General alarm</i> (The outputs are all disabled apart from the alarm output, if present)	<ul style="list-style-type: none"> • If the problem persists, contact the technical assistance service.
EU	<i>Humidifier alarm</i> (The humidifier output is disabled)	<ul style="list-style-type: none"> • Check the humidifier status. • If the problem persists, contact the technical assistance service.
EF	<i>Fans protection</i> (The fans output is disabled)	<ul style="list-style-type: none"> • Check the fans status. • If the problem persists, contact the technical assistance service.
En	<i>No connection between Console and MASTER board.</i>	<ul style="list-style-type: none"> • Check the connection between the two units. • If the problem persists, contact the technical assistance service.

Enl	<i>MASTER board initialisation error.</i>	<ul style="list-style-type: none"> • Check the connection between the two units. • Switch the Vision Touch off and on again. • If the problem persists, contact the technical assistance service.
Ec1	<i>Configuration Error Room Temperature probe</i>	<ul style="list-style-type: none"> • Check the configuration of the analogue inputs.
Ec3	<i>Configuration Error Room Humidity probe</i>	<ul style="list-style-type: none"> • Check the configuration of the analogue inputs. • Check enabling of humidity management.
Ag1	<i>General alarm 1 from digital input</i>	<ul style="list-style-type: none"> • Verify the digital input configured as 'Generic warning 1'
Ag2	<i>General alarm 2 from digital input</i>	<ul style="list-style-type: none"> • Verify the digital input configured as 'Generic warning 2'
Ag3	<i>General alarm 3 from digital input</i>	<ul style="list-style-type: none"> • Verify the digital input configured as 'Generic warning 3'
Edi	<i>Digital input configuration error during an import or update configuration.</i>	<ul style="list-style-type: none"> • Check the configuration of the digital input. • Reconfigure the input disabled.
Edo	<i>Digital output configuration error during an import or update configuration.</i>	<ul style="list-style-type: none"> • Check the configuration of the digital output. • Reconfigure the output disabled.
Eai	<i>Analogue input configuration error during an import or update configuration.</i>	<ul style="list-style-type: none"> • Check the configuration of the analogue input. • Reconfigure the input disabled.
Eao	<i>Analogue output configuration error during an import or update configuration.</i>	<ul style="list-style-type: none"> • Check the configuration of the analogue output. • Reconfigure the output disabled.

The **VISION TOUCH WELLNESS** controller in the case of any faults **in the connected Pego Easystem humidifier** informs the operator, by means of alarm codes visualised on the display (via pop-up or on the 'Alarms' page) and an acoustic signal emitted by a buzzer inside the operating Console (if enabled). One of the following messages appears on the screen when an alarm condition occurs:

ALARM CODE	POSSIBLE CAUSE	SOLUTION
E0U	<i>Functioning anomaly of the ambient probe set in variable S9.</i>	<ul style="list-style-type: none"> • Check correct configuration of used probe (variable S9 and electric connections on specific clamps). If problem persists, replace the probe.
E1U	<p><i>Maximum water level inside cylinder / Current reading problems.</i></p> <p><i>The water inside the cylinder has reached the maximum level sensor and absorbed current is below minimum threshold of 0.5A.</i></p> <p><i>Reaching of the maximum level combined with measured current too low, identifies an anomaly that should not occur in normal functioning.</i></p> <p><i>This alarm blocks steam output until its acquisition (pressing of Silence key).</i></p>	<ul style="list-style-type: none"> • Check correct insertion of the cylinder connector to humidifier. • Using an ammeter clamp, check absorption on the power supply phases; one may be interrupted. • Check wear of the cylinder electrodes. • Check water conductivity is above minimum admitted for the type of cylinder used; in particular, for normal cylinders greater than 250µS/cm and for low conductivity cylinders greater than 125µS/cm. In case, try reducing the steam output % by acting on the Pr variable to lower the working level of the water inside the cylinder.. • Suspended particles produced by oils or greases present in the charge line can cause the forming of foam that activates the level. Completely wash the cylinder a few times by means of manual discharge immediately after complete charge. • Water conductivity above 1300µS/cm can cause the forming of foam. Increase frequency of deconcentration discharges by acting on parameter S2. • Verify there is no water underneath the cable-carrier circular tube, on the upper part of the cylinder. If present, this can penetrate the circular tube and create a false contact on level. Carefully dry everything.
E2U	<i>Functioning anomaly of the channel probe set in variable S9.</i>	<ul style="list-style-type: none"> • Check correct configuration of used probe (variable S9 and electric connections on specific clamps). If problem persists, replace the probe.

E3U	<p>No water for a prolonged time. $S2 \geq 10$ and water charge outlet remains active for a time equal to ($S2$ less 1 minute), alarm E3 triggers. If $S2 < 10$ alarm E3 is deactivated.</p> <p>This alarm blocks steam output. To reset the alarm, access and exit stand-by.</p>	<ul style="list-style-type: none"> • Check the mains water line is active. • Verify there is no water leaking due to breaking. • Verify the water charge valve is not faulty or disconnected.
E5U	<p>Failed discharge control auto-test (Pre-alarm) This alarm does not block steam output; the cause of the problem must be eliminated prior to successive test performed every 10 hours of functioning of the electrodes to avoid occurring of the blocking error E6. Alarm is automatically reset upon successive discharge test if it passes or upon humidifier switch-off.</p>	<ul style="list-style-type: none"> • Check the discharge or bottom of the cylinder are not obstructed and the pump is not faulty or disconnected. • In case pump test I1 is not considered necessary, it can be disabled by bringing variable $S10=0$.
E6U	<p>Discharge control auto-test failed for second consecutive time. This alarm blocks steam output to avoid damaging the unit and cannot be silenced.</p> <p>To reset the alarm switch-off humidifier.</p>	<ul style="list-style-type: none"> • Check the discharge or bottom of the cylinder are not obstructed and the pump is not faulty or disconnected. • In case pump test I1 is not considered necessary, it can be disabled by bringing variable $S10=0$.
E8U	<p>Alarm from digital input (usually safety thermostat). This alarm starts if one of digital inputs configured as alarm persists for more than 5 seconds. It blocks the steam production and activates the acoustic signalling (can be switched off). The alarm is automatically reset when the alarm input disappears.</p>	<ul style="list-style-type: none"> • Check the alarm input. (usually safety thermostat)
E9U	<p>SERIOUS alarm from digital input (usually safety thermostat). If the E8 alarm persists continuously for a time longer than $t5$, starts the E9 serious alarm. The E9 alarm starts also if in the space of 12 hours occur 3 alarm E8 situations. It blocks the steam production to avoid the damage of the unit and it cannot be switched off. The E9 alarm is disabled with $t5=0$. To reset the alarm, the humidifier has to be switched off.</p>	<ul style="list-style-type: none"> • Check the alarm input. (usually safety thermostat)

9.3

ALARMS MANAGEMENT

By pressing the “Alarms” button one accesses the relative management page that contains the log relating to the last 30 alarms detected. The alarms can take on different colours:

- **RED ALARM:** indicates an alarm in progress, not solved.
- **ORANGE ALARM:** when a red alarm is cleared because the cause is solved, it turns orange and becomes an alarm to be acquired. If all alarms are cleared the “Alarm” button turns orange.
- **SOLVED ALARM:** the acquired alarm is no longer coloured and it stays stored in alarms management.

The screenshot shows a list of alarms with the following details:

- Red Alarm:** E1, Sensor 1 fault Ambient relative humidity probe, Begin: 11-12-2012 08:57:35. Callout: **RED ALARM** Solve the cause.
- Orange Alarm:** EtH, Maximum temperature alarm, Begin: 11-12-2012 08:55:23, Period: 1 min. 52 sec. Callout: **ORANGE ALARM** Alarm cleared. Press the alarm to acquire it.
- Solved Alarm:** E2, Sensor 2 fault Ambient temperature probe, Begin: 11-12-2012 08:51:25, Period: 1 min. 55 sec. Callout: **ALARM SOLVED** Alarm cleared and acquired by the user.
- Solved Alarm:** E3, Sensor 3 fault Evaporator temperature probe, Begin: 11-12-2012 08:50:45, Period: 2 min. 35 sec.
- Solved Alarm:** E1, Sensor 1 fault Ambient relative humidity probe, Begin: 11-12-2012 08:48:34, Period: 1 min. 35 sec.
- Solved Alarm:** ---, Device power on, Begin: 11-12-2012 08:48:11.

Bottom navigation bar includes: Back, Settings, Alarm, Help, Air cycle, Light, RGB, Standby.

The screenshot shows a list of alarms with the following details:

- Alarm code (see Diagnostics):** E2
- Alarm description:** Sensor 2 fault Ambient temperature probe
- Alarm situation duration:** Period: 0 min. 3 sec.
- Alarm status (in progress | cleared | solved):** Cleared (indicated by a checkmark)
- E-MAIL SENT:** If emails are enabled, it indicates the attempt to send an email related to the alarm (indicated by an envelope icon).
- Alarms list deletion:** (button present only if all alarms have been solved) - indicated by a trash can icon.
- Date and time the alarm situation started:** 13-4-2015 09:32:47

Bottom navigation bar includes: Back, Settings, Alarm, Help, Air cycle, Light, RGB, Standby.

Pop-ups are elements that appear on the screen in order to call the user's attention to particular situations that may occur during the normal use of the VISION TOUCH WELLNESS control unit.



RED POP-UP

It may indicate:

- activated alarm warning
- the action that one is about to perform is critical and irreversible. Pay particular care when confirming the operation.



BLUE POP-UP

Device start-up
(date and time are stored in alarms management)

CHAPTER 10: WEB SERVER

10.1

INSTALLATION

The Web configuration of the Vision Touch Wellness depends on the type of connection.

- Direct connection to the PC



The network card of the computer must be configured in order to have the assignment of the DHCP address activated. In this case, the Vision Touch Wellness and the computer, finding no DHCP server, will take the default IP addresses previewed for the class of addressing 169.254.xxx.xxx. In order to connect to the device, it will be necessary to open up a browser page and digit in the address bar the following order:

<http://hostname/> where hostname = unique identifier linked to the serial number present in the info page (Take look at “Info Page”, chap. 8.3.7).

or

<http://169.254.254.1/> (IP default address of the Vision Touch)

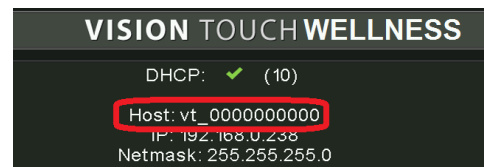

- LAN Connection

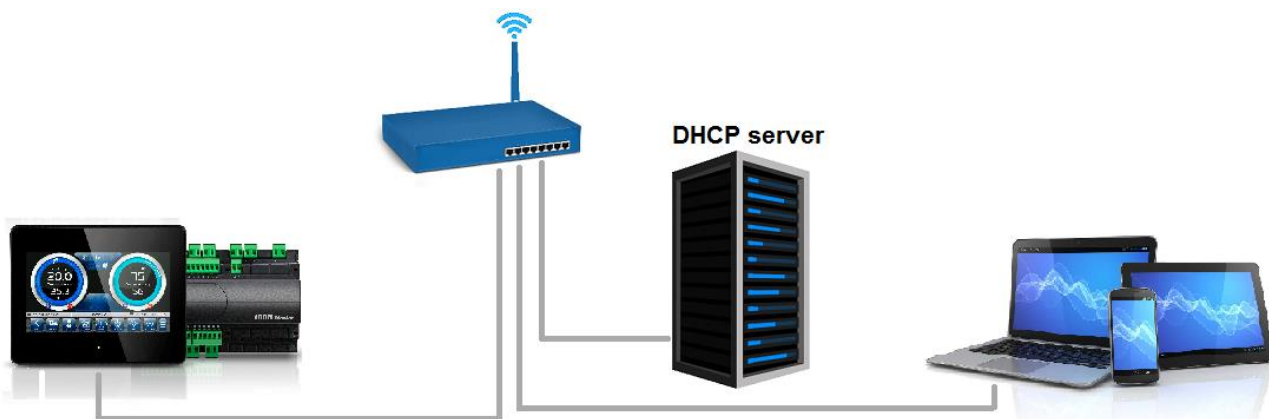

If connected to a LAN where a DHCP server is present (and the DHCP solicitude is enabled on the Vision Touch, look at chap. 8.3.7), the Vision Touch will acquire a free IP address. In this case it is possible to consult the IP address acquired through the “Info Page” that you find in the “Web server” menu of the Vision Touch.

If the DHCP is not present, Vision Touch maintains the IP address set in the configuration of the parameters.

Pay attention: in this case, IP conflicts with other devices connected to the LAN could be possible.

In order to connect to the Vision Touch, it will be necessary to connect your own device to the same net, in DHCP mode, or with compatible static IP, open up a browser and digit in the address bar the following order:

<http://hostname/> where hostname = unique identifier linked to the serial number present in the info page (look at “Info Page”, chap. 8.3.7).

or

<http://XXX.XXX.XXX.XXX/> (Vision Touch IP address, look at “Info Page”, chap. 8.3.7)

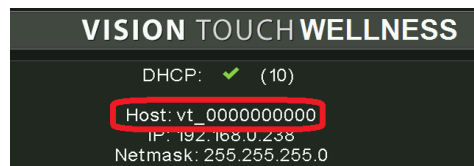

NOTE: The Host name of the Vision Touch is a unique reference linked to the serial number. So that it is possible to connect different Vision Touch devices using the same LAN net, setting distinct IP addresses in case that a DHCP server is not available.

For if you desire to join the Vision Touch from the web browser, it is sufficient to write in the address bar:

http://vt_xxxxxxxxx/

Where xxxxxxxxxxx = serial number of the device

10.2 WEB INTERFACE: USER ACCESS

The access to the Web page of the Vision Touch is subject to the access control through Username and Password.

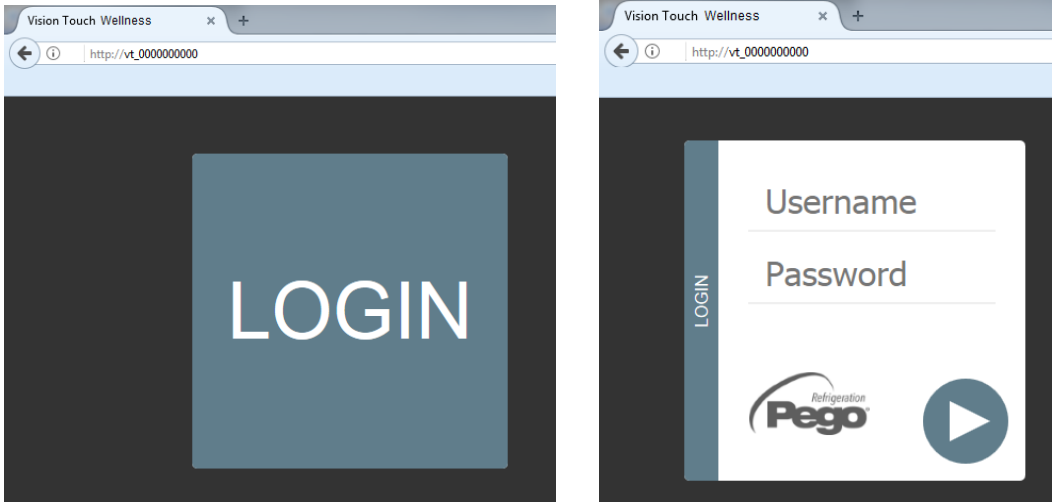

It is possible to access to the Web pages of the Vision Touch in other two modes:

- *basic user*: inserting in the “Username” field the user Name set in the “Web server” menu of the Vision Touch (page “Username”), you log in with the same permits that the basic user has on the Vision Touch. The installer, inhibiting the functions or the access to the parameters to the local user, also blocks the access to such features to the basic user who logs in through the Web page.
- *admin user*: inserting in the “Username” field the user Name set in the “Web server” menu of the Vision Touch (page “Username”), and in the “Password” field, the installer password of the Vision Touch (the one used in the Password menu in order to access as installer) you log in with the same permits that the installer has on the Vision Touch. So, it is possible to edit the parameters and access to all the functions (if the Wce parameter supports the remote command, look at chap. 8.3.7).

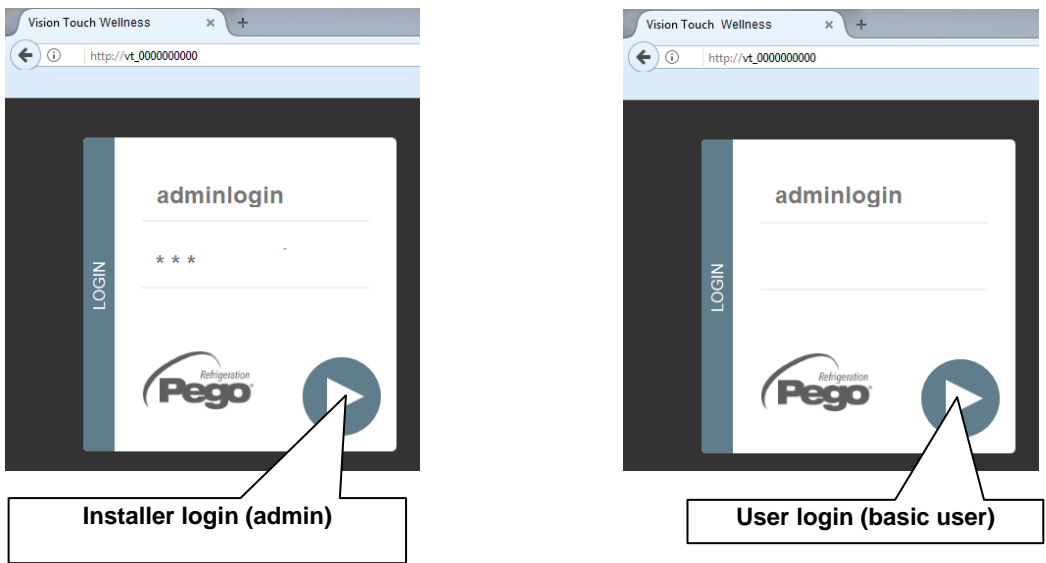

The web interface counts with some fixed sections:

- On the left: browsing menu of the pages.
- At the top: name of the page, serial number and kind of connected user.
- On the right: content of the page.

- Homepage

The screenshot shows the Pego Vision Touch Wellness web interface. It features a dark blue sidebar on the left with a menu: Live, PEGO Humidifier, I/O, Alarms, Command ▾, Info, and Logout. The main content area has a header with the Pego logo and 'Vision Touch Wellness'. Below the header, it displays 'Live' and 's/n: 0000000001 - admin'. The central part of the page shows two large data cards: a red one for Temperature (25.3 °C) and a blue one for Humidity (38 HR%). Below these are four control buttons: Standby (green), Light (blue), RGB (green), and Air cycle (grey). At the bottom, there is a footer with 'Copyright © Pego srl'.

Browsing menu of the pages

Actual page

Actual temperature (and temperature set point)

Actual humidity (and humidity set point)

Kind of access (admin or basic user)

Logout
Logs the user out and brings him back to the login page

Warning signal
- red: red flag alarm
- grey: no alarm

Buttons
- green background: active function
- blue background: inactive function
- grey background: inactive and inactivable function (basic user)

- PEGO Humidifier

The “Humidifier PEGO” page is visible only if the humidifier is enabled (EUm=1). The “Stand-by” and “Discharge” buttons are disabled if web commands are disabled (Wce=0 in Webserver menù) or if the user is not enabled.

The screenshot shows the Vision Touch Wellness web interface for a PEGO Humidifier. The interface includes a sidebar menu with options: Live, PEGO Humidifier, I/O, Alarms, Command, Info, and Logout. The main content area displays the humidifier's status and controls. A central image shows the humidifier unit with steam rising from it. To the right of the image are three large digital displays: TA current (A) showing 0, Production (%) showing 0, and Operating hours showing 4. Below these displays are two buttons: Standby and Discharge. The interface also features sections for Inputs and Outputs, each with several icons representing different digital signals. Callout boxes provide additional information: 'Humidifier (steam present with active steam production)' points to the steam image; 'Humidifier's digital inputs' points to the Inputs section; 'Humidifier's outputs' points to the Outputs section; 'Stand-by Humidifier' points to the Standby button; and 'Forcing manual discharge humidifier' points to the Discharge button. The footer of the interface includes 'Copyright © Pego srl'.

- I/O (Inputs / Outputs)

VISION TOUCH WELLNESS

s/n: 000000001 - admin

Analogue inputs

27-28	Humidity probe [°C]	39
29-30	Ambient temperature [°C]	25.3
31-32	Disabled	
33-34	Disabled	
35-36	Disabled	

Digital outputs

3-4	Hot 1 (N.O.)	●
5-6	Hot 2 (N.O.)	●
7-8	Hot 3 (N.O.)	●
9-10	Fans (N.O.)	●
11-12	Humidify (N.O.)	●
13-14	Light (N.O.)	●
15-16	Light RGB (N.O.)	●
25-26	Disabled	●
23-24	Disabled	●
21-22	Disabled	●
19-20	Disabled	●
17-18	rm (N.O.)	●

Copyright © Pego srl

**Input / Output Clamp
PIN on the 100N
MASTER**

**Input / Output
description (digital or
analogical)**

Input / Output status
 If digital:
 - green: active input / output
 - grey: inactive input / output

 If analogical:
 You visualize the analogical input /
 output value

- Alarms

In the “Alarms” page are visualized all the red flag alarms and those which have intervened, such as they are memorized in the Alarms page of the Vision Touch (look at chap. 9.3, Alarm Gesture).

The background color is indicative for the type of alarm:

- Red background: red flag alarm (the starting instant is indicated).
- Yellow background: annulled alarm (the starting instant and the duration are indicated).
- White background: alarm annulled and acquired on the Vision Touch.

NOTE: one cannot proceed to the acquisition of the alarms using the Web page.

The screenshot shows the 'Alarms in progress' section of the Vision Touch Wellness web interface. The table contains the following data:

Code	Alarm
E2	Sensor 2 fault Ambient temperature probe Begin: 26-1-2018 12:04:17
Eg	General alarm Begin: 26-1-2018 12:02:50 Period: 0 min. 3 sec.
---	Device power on Begin: 26-1-2018 12:02:28

Callouts from the bottom of the screenshot point to the 'Code' column (labeled 'Alarm code') and the 'Alarm' column (labeled 'Description and duration of the alarm').

- Command => Program

The display of the "Program" page depends on the enabling of the Weekly programmable thermostat (EnC parameter).

=> EnC = 0 (Weekly thermostat disabled)

If sauna / turkish bath on stand-by:

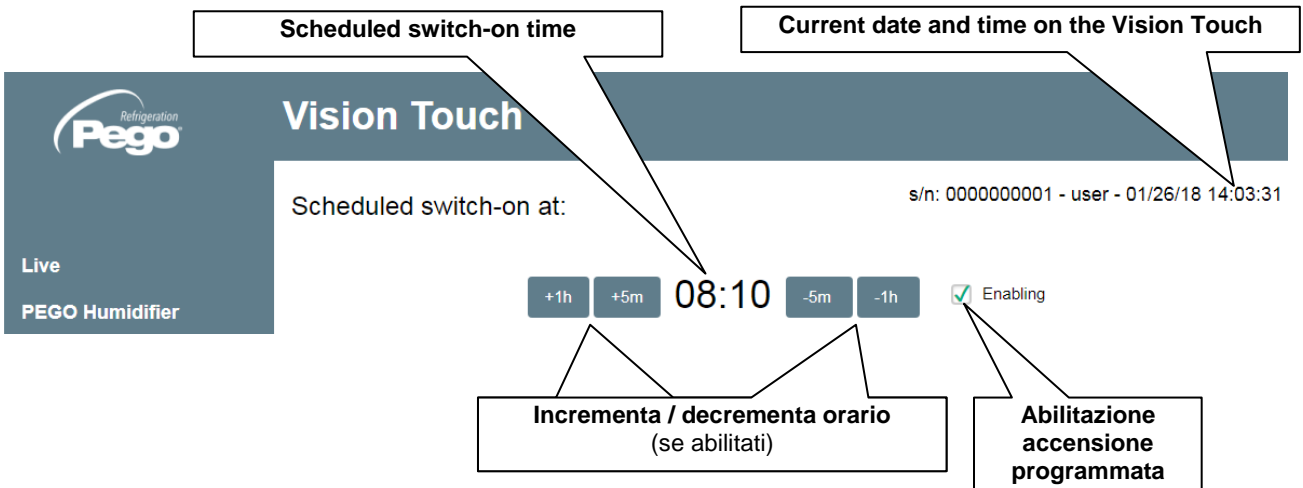

If sauna / turkish bath not on stand-by:

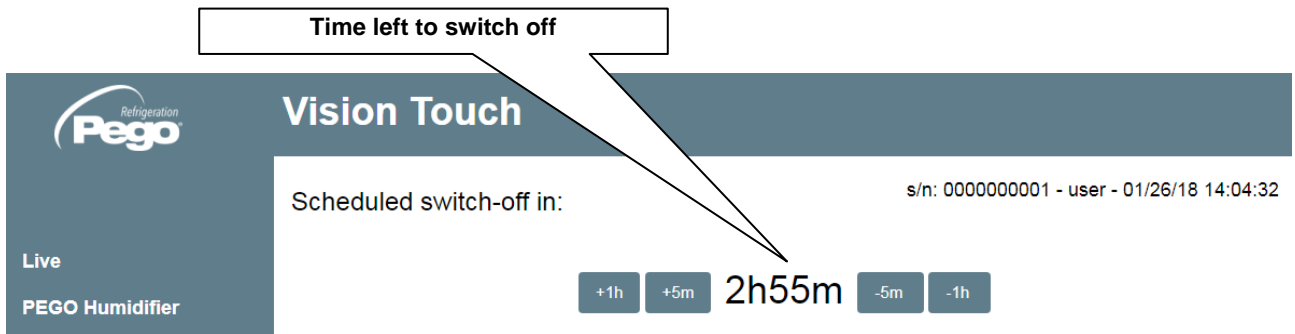

=> EnC = 1 (Weekly thermostat enabled)

Days of the week
(click on the button to enter the edit page)

Current date and time on the Vision Touch

Vision Touch

Weekly programmable thermostat

s/n: 0000000001 - user - 01/26/18 14:07:30

Day	M	T	W	T	F	S	S
Schedule:	07:00	---	07:00	---	---	---	---
Period:	1h0m	---	1h0m	---	---	---	---
Schedule:	15:00	---	---	---	21:00	---	---
Period:	3h0m	---	---	---	2h0m	---	---

First and second ignition cycle settings
(time and duration)

Weekly chronothermostat time change page

Change settings 1 and 2
- enabling
- schedule
- duration

Confirm and send data to the Vision Touch
(the table is updated within a few seconds)

- Command => Chromotherapy

Enable automatic RGB light color cycle (if on)

Selected color
15

+ - Automatic cycle

RGB light color set

Manual selection of RGB light color (if on)

Chromotherapy

s/n: 000000001 - user

Refriegeration Pego

Live
PEGO Humidifier
I/O
Alarms
Command ▾
Info
Logout

- Command => Parameters

Parameters menu hidden to the basic user (configuration in the Password menu on the Vision Touch)
Note: the admin user always has access to the complete list of the menu.

Parameters menu
 Click on the indicator in order to visualize the list of the parameters.

Parameters

Setpoint ▾

Process regulation ▾

WELLNESS configure ▾

Probes calibration ▾

RGB ▾

Parameters menu hidden to the basic user (configuration in the Password menu on the Vision Touch)
 Note: the admin user always has access to the complete list of the menu.

Parameters menu
 Click on the indicator in order to visualize the list of the parameters.

Parameters

s/n: 000000001 - user

Refriegeration Pego

Live
PEGO Humidifier
I/O
Alarms
Command ▾
Info
Logout

Copyright © Pego srl

Parameter code	Parameter description	Actual value	Enhance or decrease the value
dtC	Hot temperature differential	2.0 °C	+ -
dUU	Humidification differential	5 Rh%	+ -
tf	Time of operation	1:00	+ -

- Info

Refrigeration Pego
VISION TOUCH WELLNESS
 Info s/n: 0000000001 - user

Refrigeration Pego
 Pego srl
 www.pego.it
 info@pego.it
 Tel: +39 0425 762906
 Fax: +39 0425 762905

Hardware version:
 0.0.0.3
 Bootloader version:
 187.0.0.3
 Application version:
 5.0.0.1
 Touch version:
 5

Copyright © Pego srl

CHAPTER 11: OPERATION

WELLNESS CONFIGURATION: SAUNA

11.1

Set parameter mOd = 0 to configure the control in "Sauna secca" (dry sauna) mode (or "sauna Finlandese" [Finnish sauna]). In this case a temperature probe must be configured and connected to the controller. Environmental humidity probes do not need to be connected. The hot function is activated below the set temperature - dtC and remains on until the set temperature is reached.

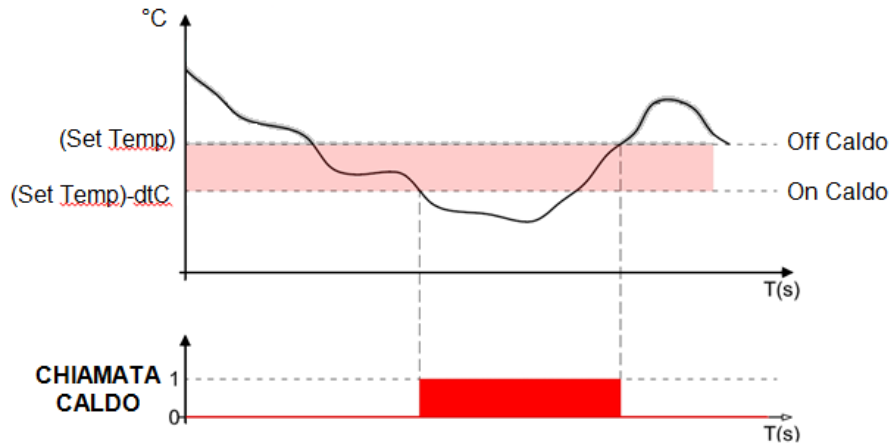

WELLNESS CONFIGURATION: WET SAUNA

11.2

Set parameter mOd = 1 to configure the control in "Sauna con umidità" (Sauna with humidity) mode (or Biosauna). In this case a temperature probe and an environmental humidity probe must be configured and connected to the controller. The temperature and environmental humidity setpoints can be set independently. The VISION TOUCH control independently controls the conformity of the set values in accordance with European Standard EN 60335-2-53:2012: in the case of violation the humidity setpoint is saturated according to the chart below.

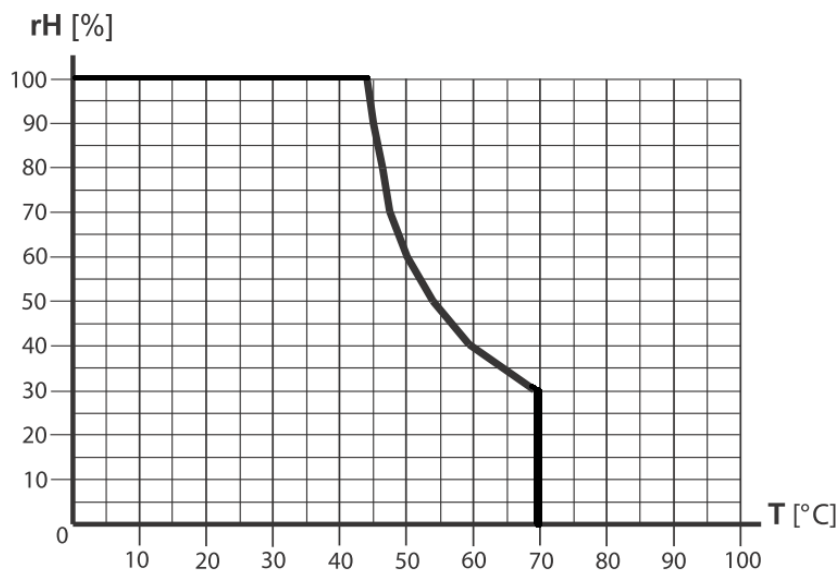

Note. If the ambient temperature is greater than 70°C, the humidifying call is disabled.

The normal operation of the Sauna with humidity is indicated below.
 The hot is activated below set - dtC and remains active until set is achieved.

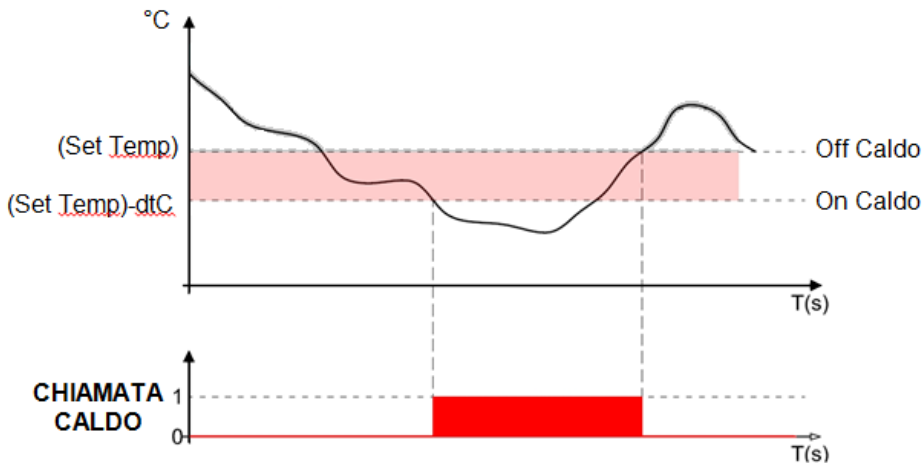

Humidification is activated below set - dUU and remains active until set is achieved.

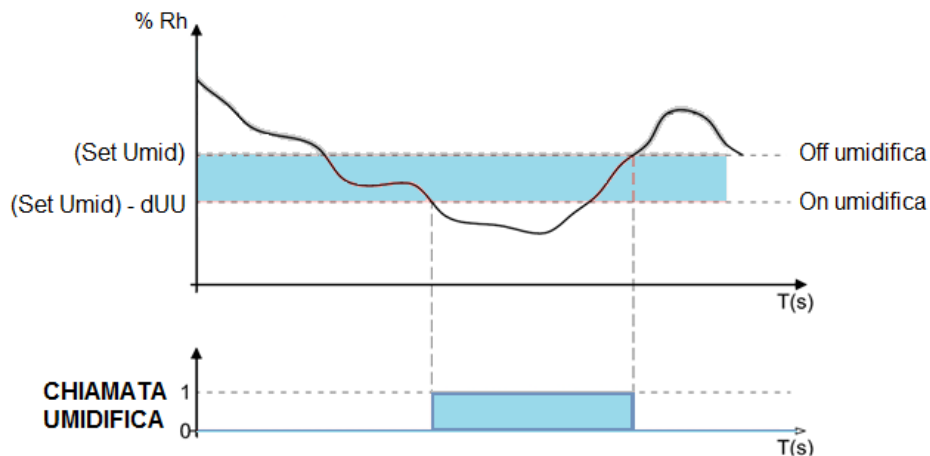

11.3 WELLNESS CONFIGURATION: TURKISH BATH

Set parameter mOd = 2 to configure the control in "Turkish bath" mode. In this case a Pego EasySteam humidifier must be connected to terminals 37-38 of the 100N Master (see chap. 8.3.7) and configure the parameters correctly.

This type of operation involves the production of steam in two ways: no production or production at maximum speed. The maximum speed is activated when the temperature measured by the environment probe (connected to the humidifier) drops below the temperature - r1 SET POINT value and remains active until the temperature rises and exceeds the temperature SET POINT (r1=Temperature differential referred to the set point, see Parameters in PEGO Humidifiers).

In this configuration, connect a single temperature probe to terminals 18-19 of the electronic board MasterHUM2 of the humidifier.

The temperature read by the probe is displayed on the "Home1" on the controller Vision Touch.

We recommend to use the exit "Warm 1" of Vision Touch as consent the start of the humidifier (terminals 24 and 25).

The setpoint and the parameters r1 and HSE of the humidifier are overwritten by the setpoint and the parameters HSt and dtC set to the controller Vision Touch.

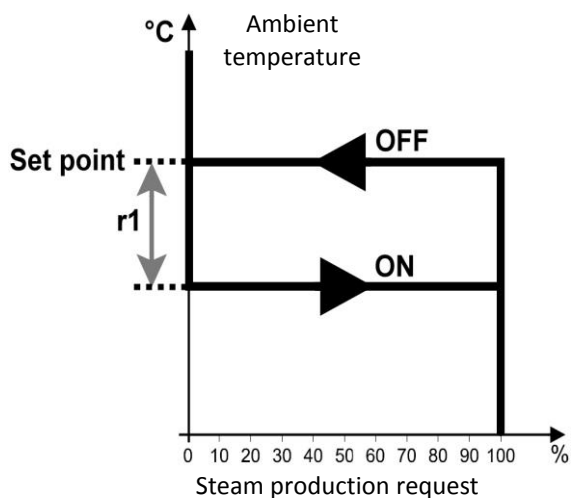

For more details refer to the manual of the Pego EasySteam humidifier (in second level parameter configuration **S9=7**).

In this operating mode it is possible to measure the humidity value inside the Turkish bath, if the humidity probe is configured on the Vision Touch.

NEW SOFTWARE FEATURES

11.4

- Screensaver function. **Rel. 5.0.1.0**
- Webserver function. **Rel. 5.0.0.1**
- Added automatic time synchronization via the Web. **Rel. 5.0.2.1**
- Added the possibility to measure the humidity value also in Turkish bath mode. **Rel. 5.0.0.2**
- Automatic sending of e-mail in case of alarm.

CHAPTER 12: ACCESSORIES

400SAUNASENS 12.1

Temperature sensor with overheating protection fuse (141 °c) for sauna.



Connection example:

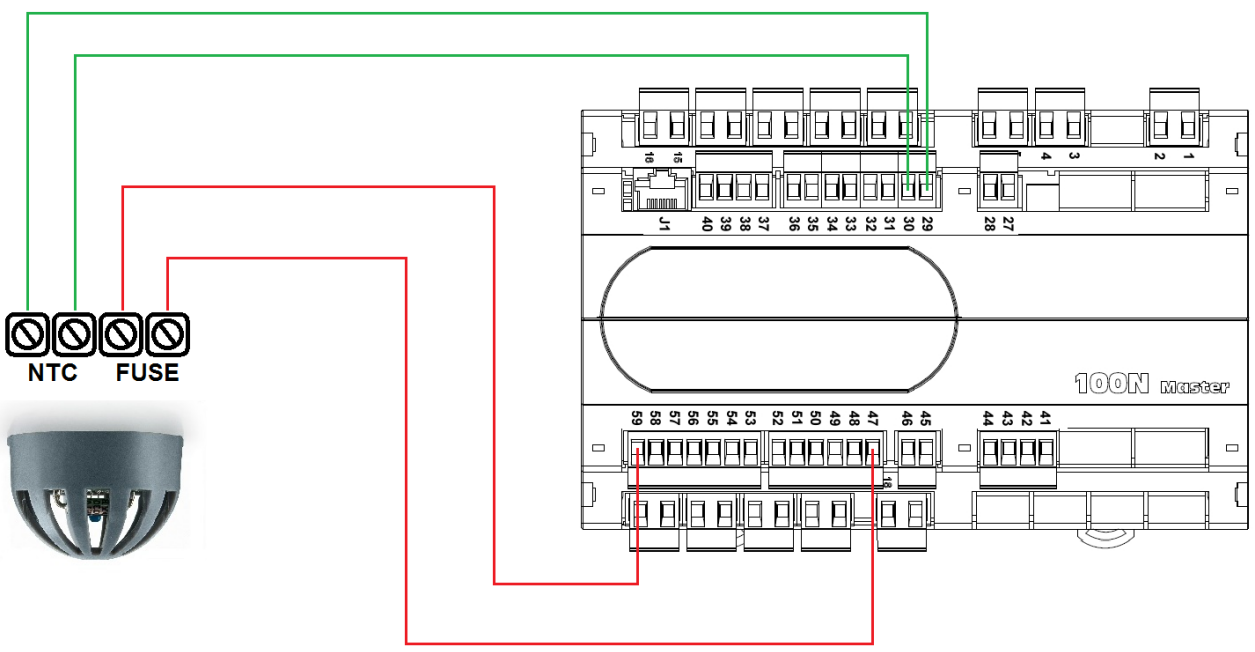

APPENDICES

A.1

DICHIARAZIONE DI CONFORMITÀ UE

LA PRESENTE DICHIARAZIONE DI CONFORMITÀ E' RILASCIATA SOTTO LA RESPONSABILITÀ ESCLUSIVA DEL FABBRICANTE:

THIS DECLARATION OF CONFORMITY IS ISSUED UNDER THE EXCLUSIVE RESPONSIBILITY OF THE MANUFACTURER:



PEGO S.r.l. Via Piacentina 6/b, 45030 Occhiobello (RO) – Italy –

DENOMINAZIONE DEL PRODOTTO IN OGGETTO / DENOMINATION OF THE PRODUCT IN OBJECT

MOD.: VISION TOUCH WELLNESS (cod. 200VT100WEL1)

IL PRODOTTO DI CUI SOPRA E' CONFORME ALLA PERTINENTE NORMATIVA DI ARMONIZZAZIONE DELL'UNIONE EUROPEA:

THE PRODUCT IS IN CONFORMITY WITH THE RELEVANT EUROPEAN HARMONIZATION LEGISLATION:

Direttiva Bassa Tensione (LVD): **2014/35/UE**
Low voltage directive (LVD): 2014/35/EU

Direttiva EMC: **2014/30/CE**
Electromagnetic compatibility (EMC): 2014/30/EU

LA CONFORMITÀ PRESCRITTA DALLA DIRETTIVA E' GARANTITA DALL'ADEMPIMENTO A TUTTI GLI EFFETTI DELLE SEGUENTI NORME:

THE CONFORMITY REQUIRED BY THE DIRECTIVE IS GUARANTEED BY THE FULFILLMENT TO THE FOLLOWING STANDARDS:

Norme armonizzate: **EN 61010-1:2010, EN 61326-1:2013**
European standards: EN 61010-1:2010, EN 61326-1:2013

IL PRODOTTO E' COSTITUITO PER ESSERE INCORPORATO IN UNA MACCHINA O PER ESSERE ASSEMBLATO CON ALTRI MACCHINARI PER COSTITUIRE UNA MACCHINA CONSIDERATE DALLA DIRETTIVA: 2006/42/CE "Direttiva Macchine".

THE PRODUCT HAS BEEN MANUFACTURED TO BE INCLUDED IN A MACHINE OR TO BE ASSEMBLED TOGETHER WITH OTHER MACHINERY TO COMPLETE A MACHINE ACCORDING TO DIRECTIVE: EC/2006/42 "Machinery Directive".

Firmato per nome e per conto di:
 Signed for and on behalf of:

Luogo e Data del rilascio:
 Place and Date of Release:

Pego S.r.l.
 Lisa Zampini
 Procuratore Generale

Occhiobello (RO), 08/01/2018

The VISION TOUCH WELLNESS electronic controllers are covered by a 24-months warranty against all manufacturing defects as from the date indicated on the product ID code.

In case of defect the product must be appropriately packaged and sent to our production plant or to any authorized Service Center with the prior request of the Return Authorization Number.

Customers are entitled to have defective products repaired, spare parts and labour included. The costs and the risks of transport are at the total charge of the Customer. Any warranty action does not extend or renew its expiration.

The Warranty does not cover:

- Damages resulting from tampering, impact or improper installation of the product and its accessories.
- Installation, use or maintenance that does not comply with the instructions provided with the product.
- Repair work carried out by unauthorized personnel.
- Damage due to natural phenomena such as lightning, natural disasters, etc...

In all these cases the costs for repair will be charged to the customer.

The intervention service in warranty can be refused when the equipment is modified or transformed.

Under no circumstances **Pego S.r.l.** will be liable for any loss of data and information, costs of goods or substitute services, damage to property, people or animals, loss of sales or earnings, business interruption, any direct, indirect, incidental, consequential, damaging, punitive, special or consequential damages, in any way whatsoever caused, whether they are contractual, extra contractual or due to negligence or other liability arising from the use of the product or its installation.

Malfunction caused by tampering, bumps, inadequate installation automatically declines the warranty. It is compulsory to observe all the instructions in this manual and the operating conditions of the product.

Pego S.r.l. disclaims any liability for possible inaccuracies contained in this manual if due to errors in printing or transcription.

Pego S.r.l. reserves the right to make changes to its products which it deems necessary or useful without affecting its essential characteristics.

Each new release of the Pego product user manual replaces all the previous ones.

As far as not expressly indicated, is applicable the Law and in particular the art. 1512 C.C. (Italian Civil Code).

For any controversy is elected and recognized by the parties the jurisdiction of the Court of Rovigo.



PEGO s.r.l.
Via Piacentina, 6/b 45030 Occhiobello ROVIGO – ITALY
Tel. +39 0425 762906 Fax +39 0425 762905
e.mail: info@pego.it – www.pego.it

AFTER-SALES ASSISTANCE CENTRE
Tel. +39 0425 762906 e.mail: tecnico@pego.it

Distributor: